

LEGO SYSTEM™

6979





1

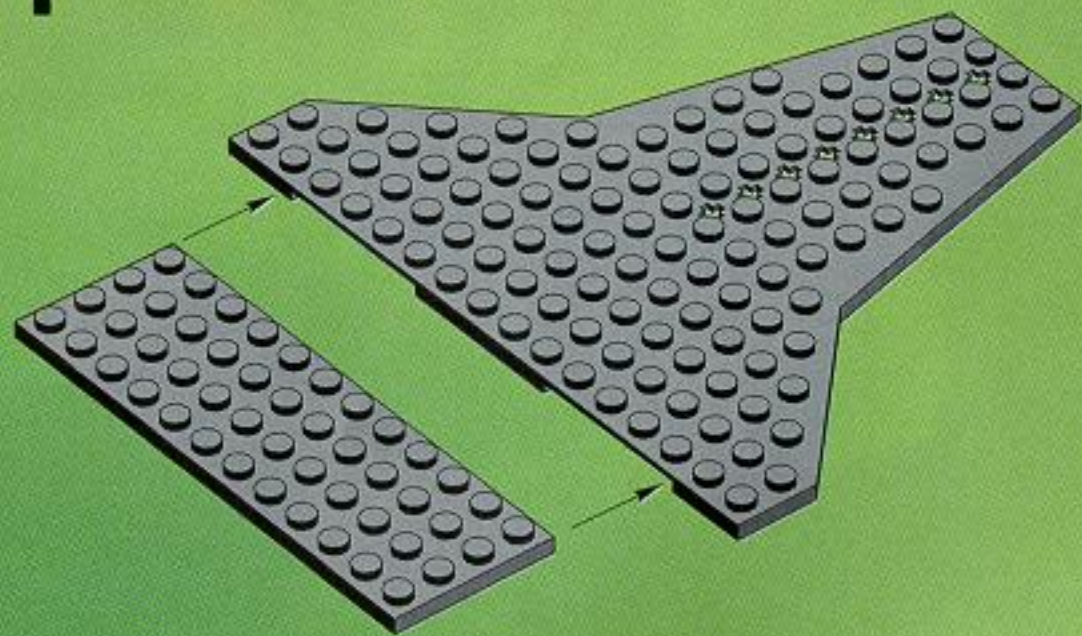

2

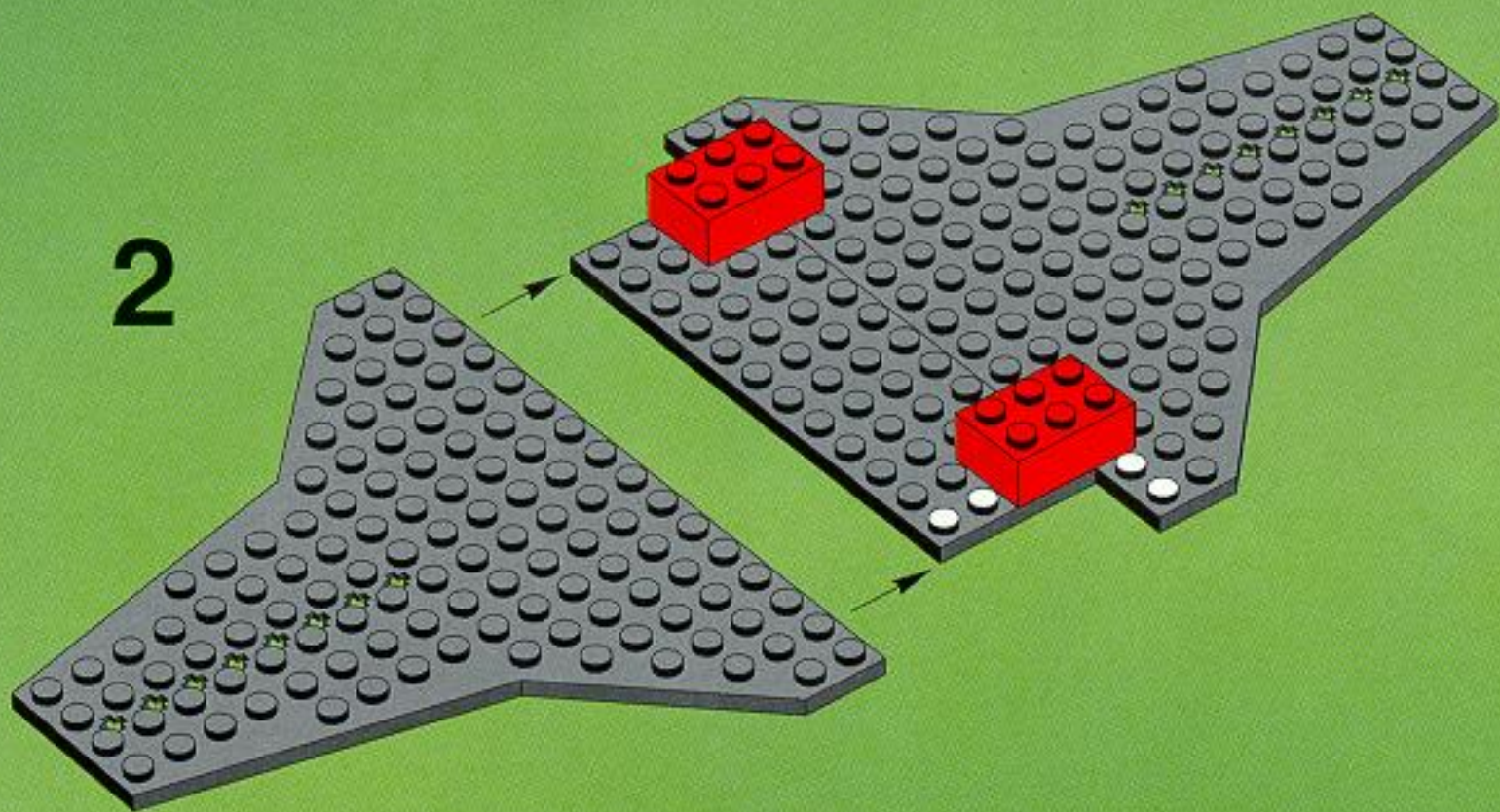

3

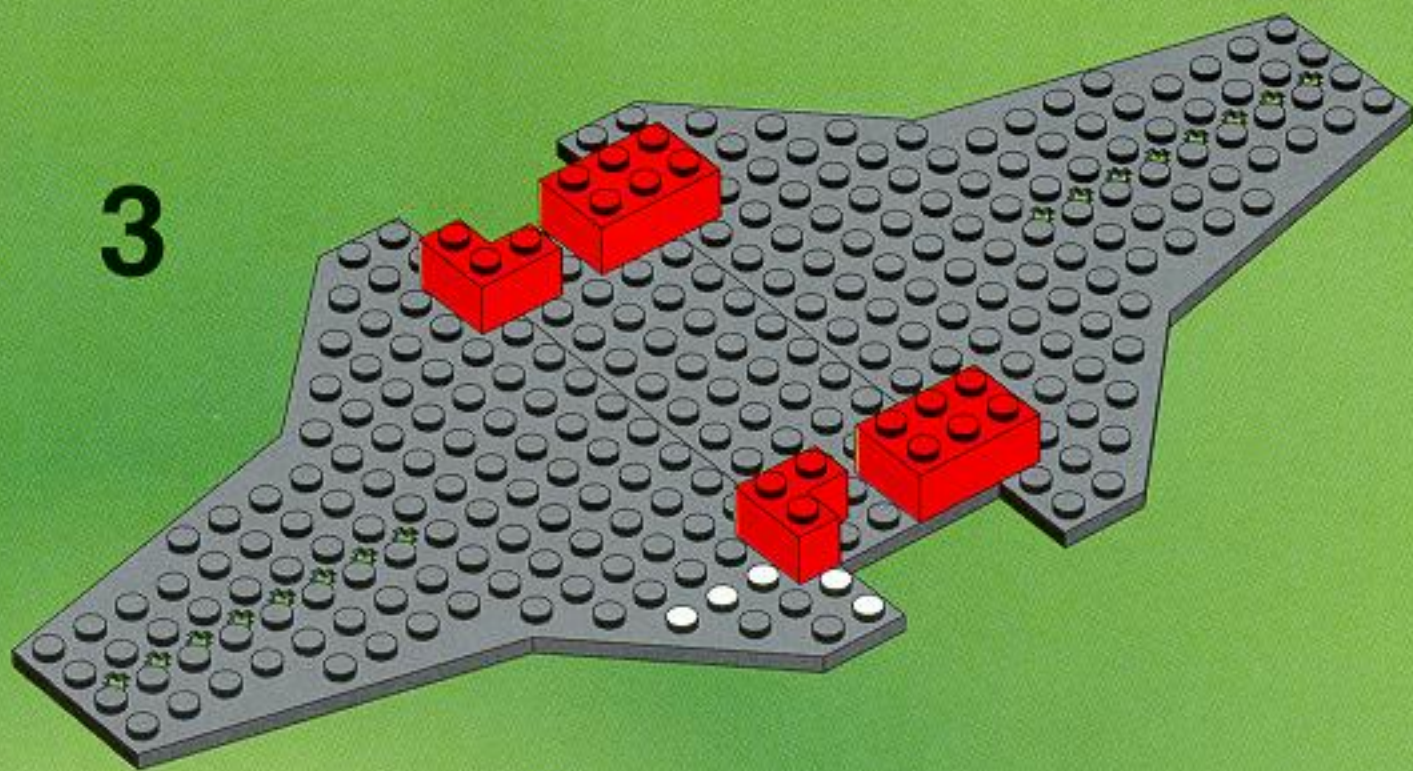

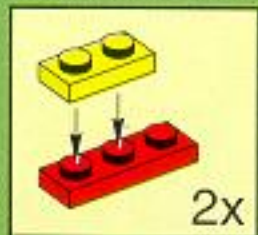

4

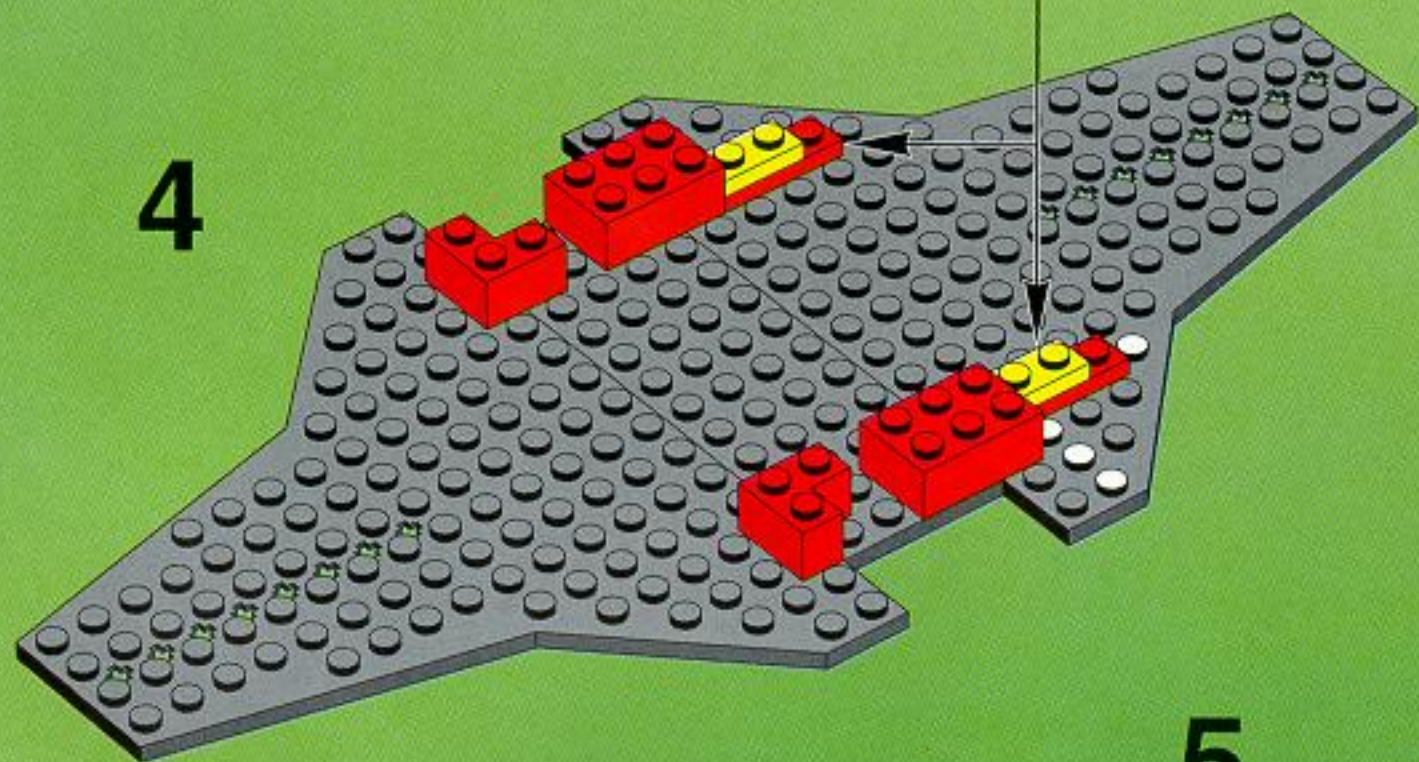

5

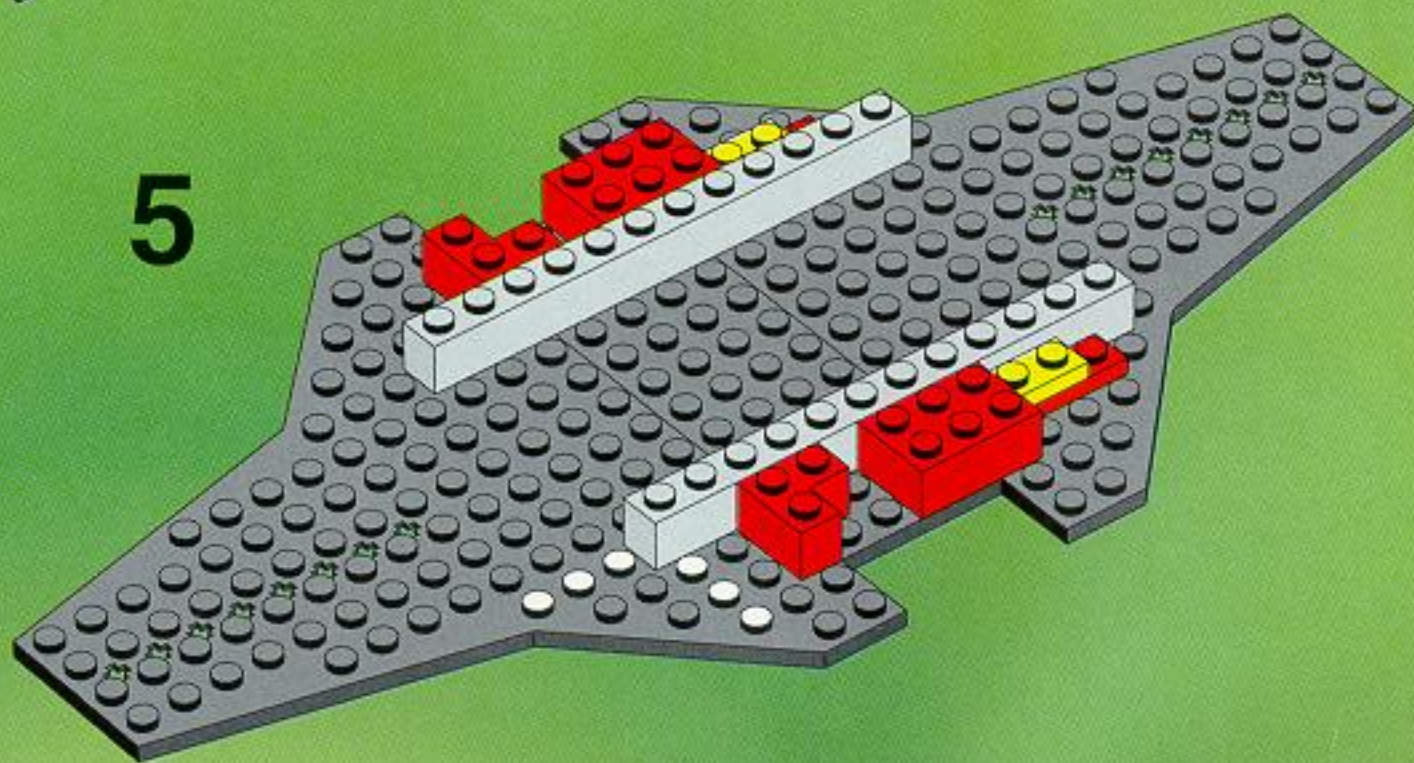

6

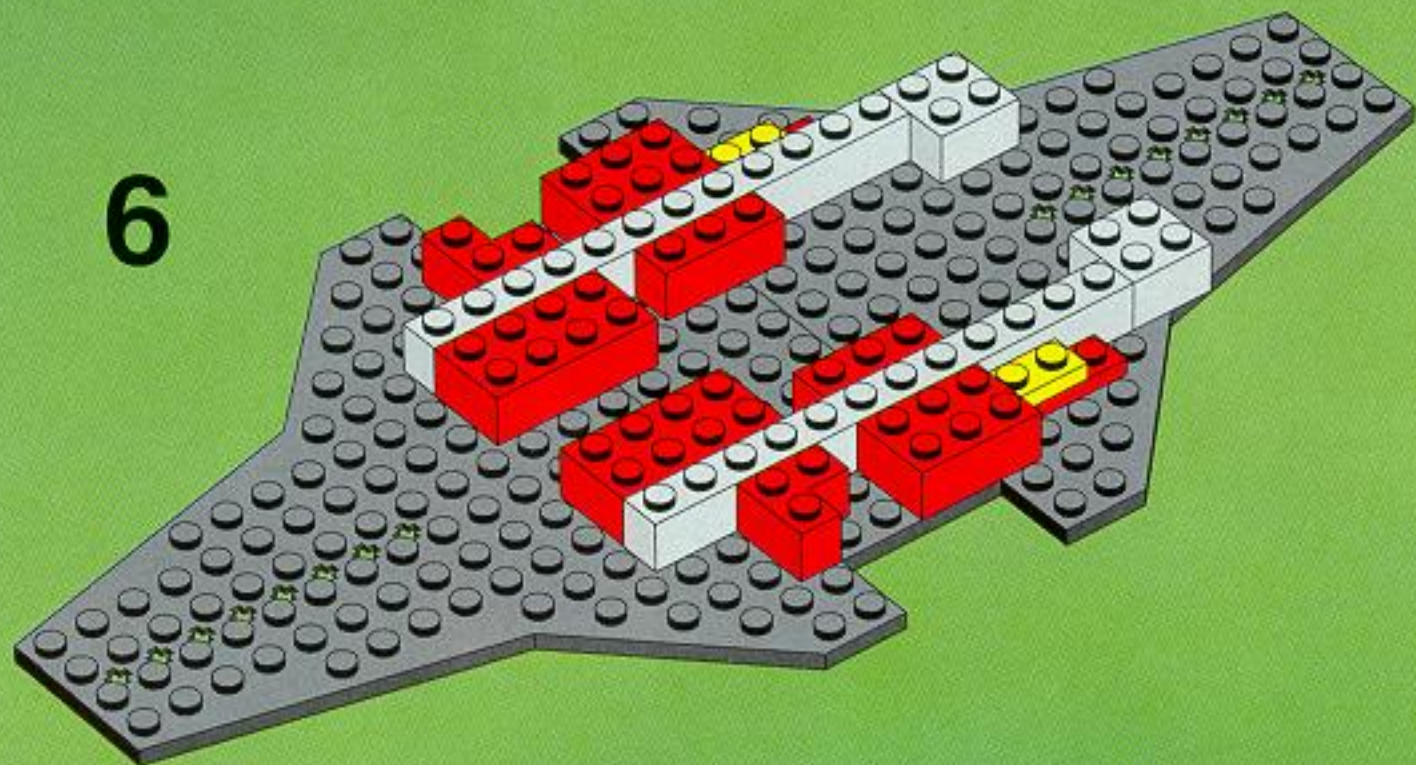

7

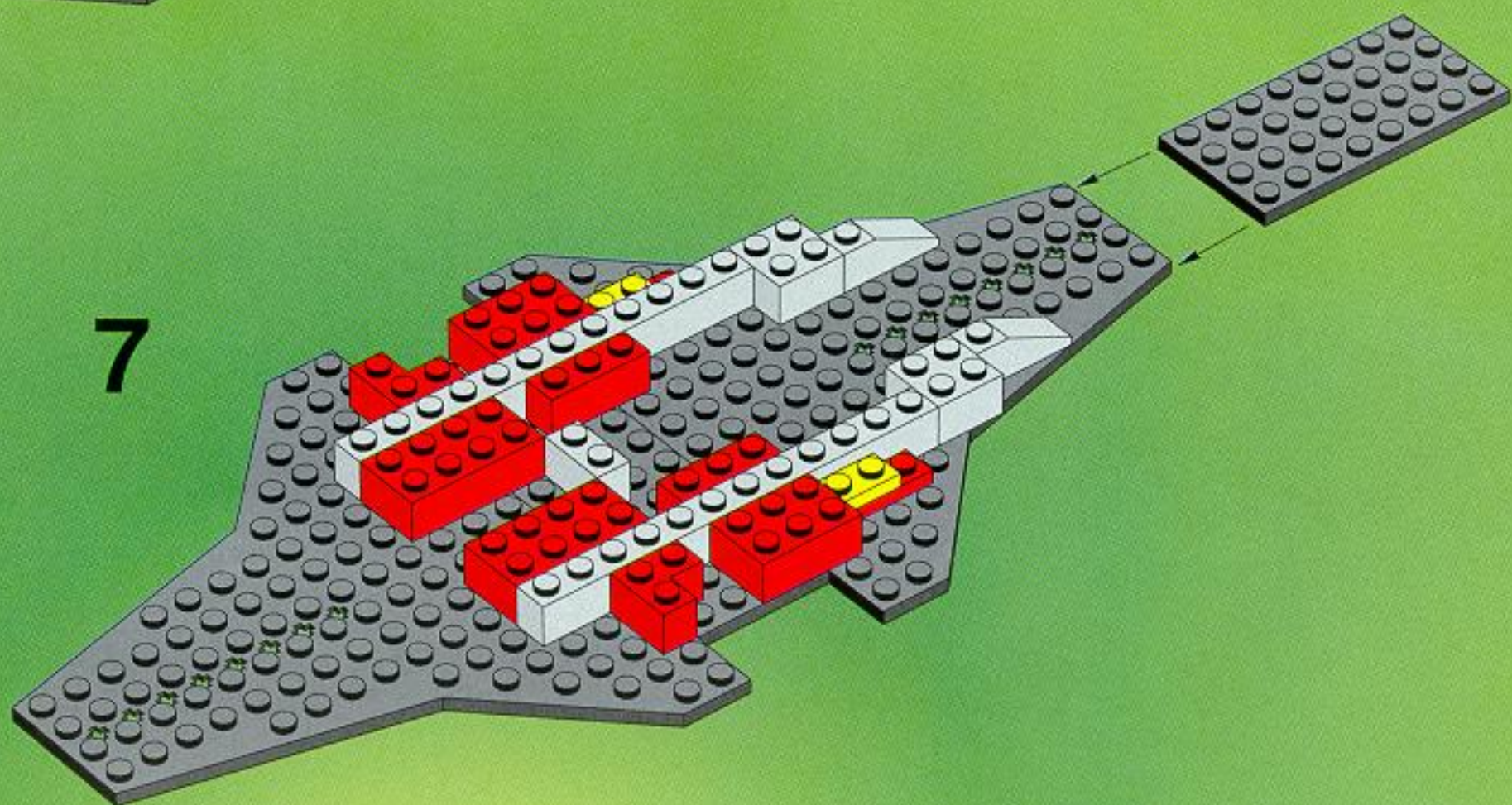

8

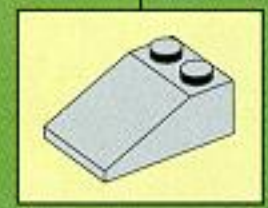
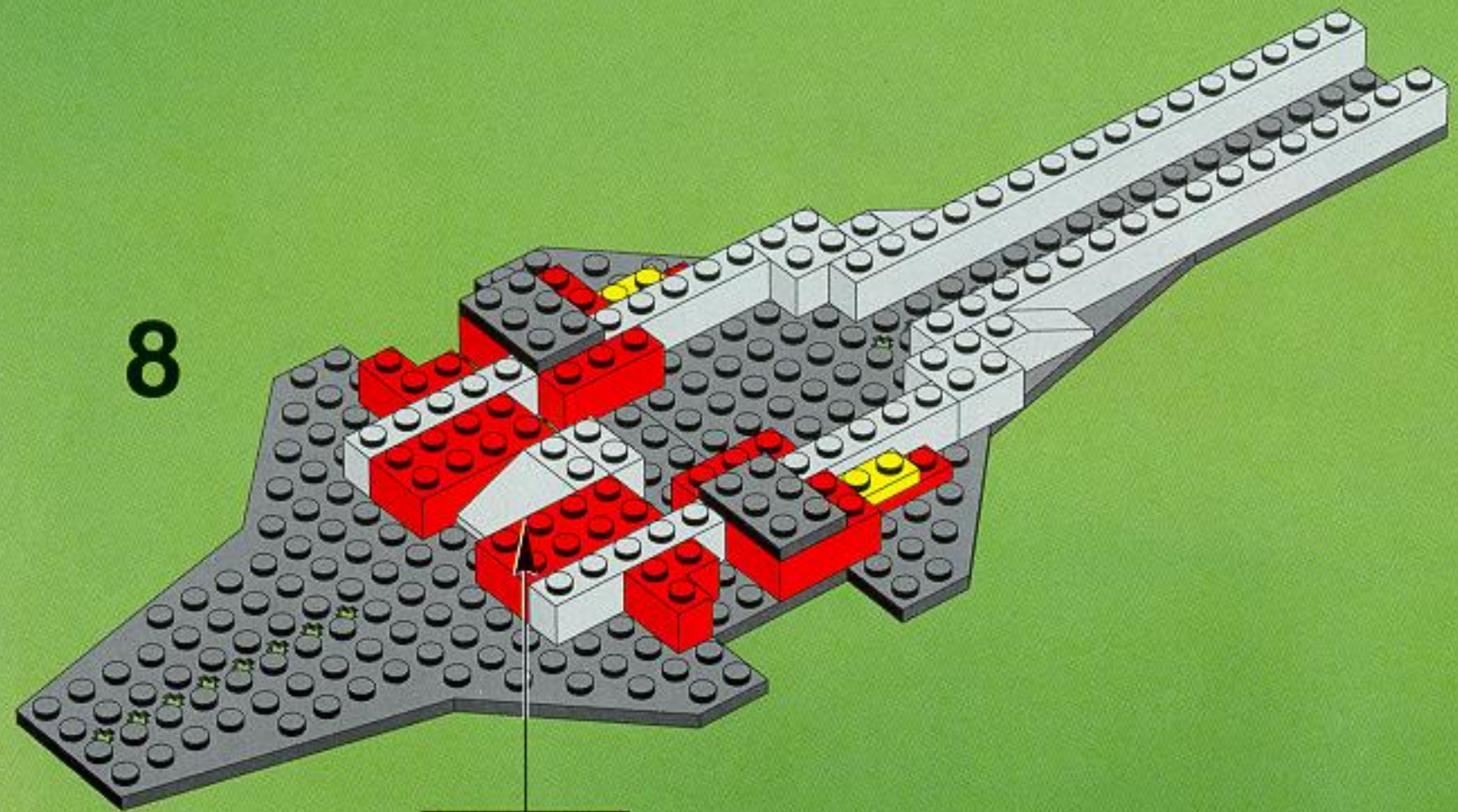

9

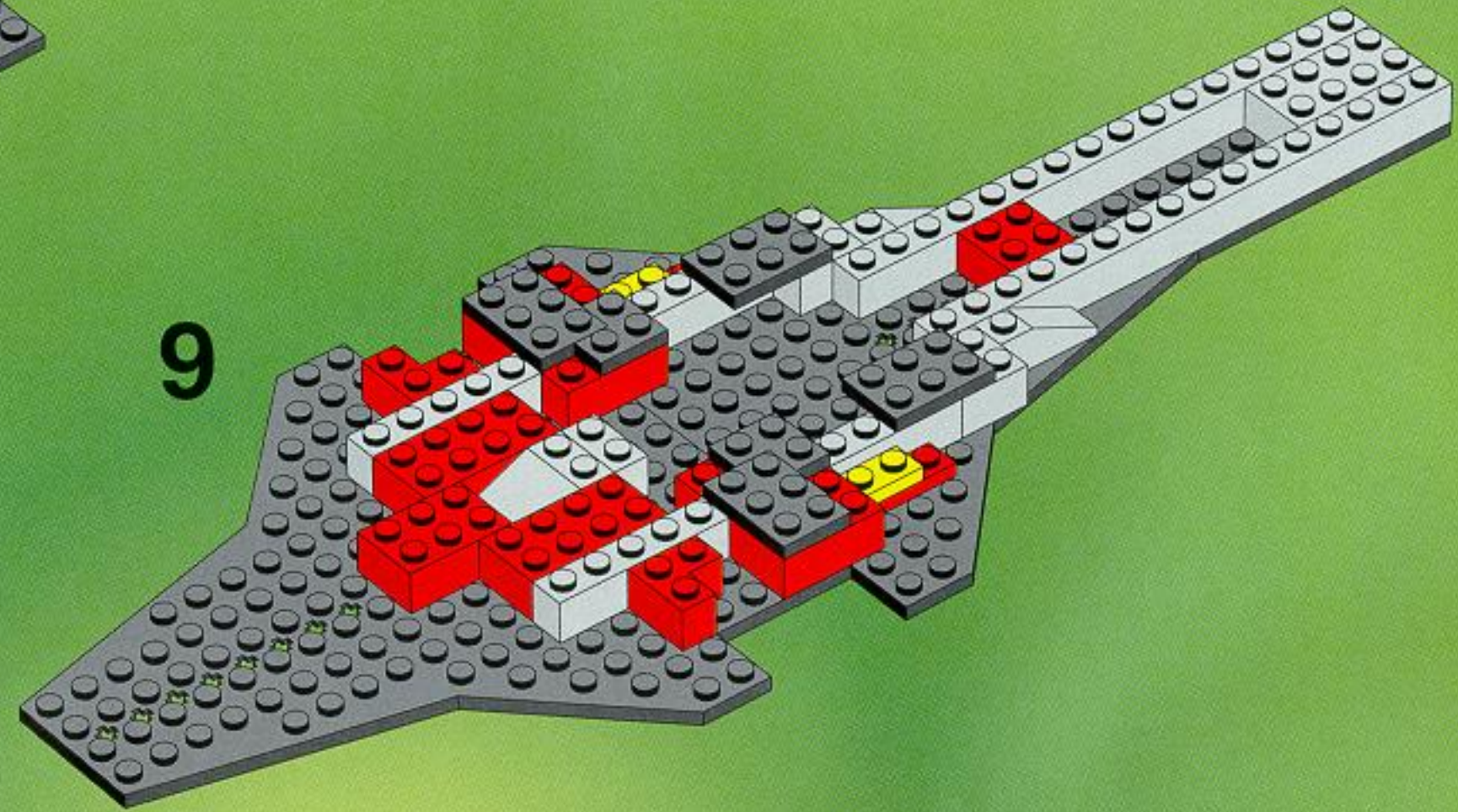

10

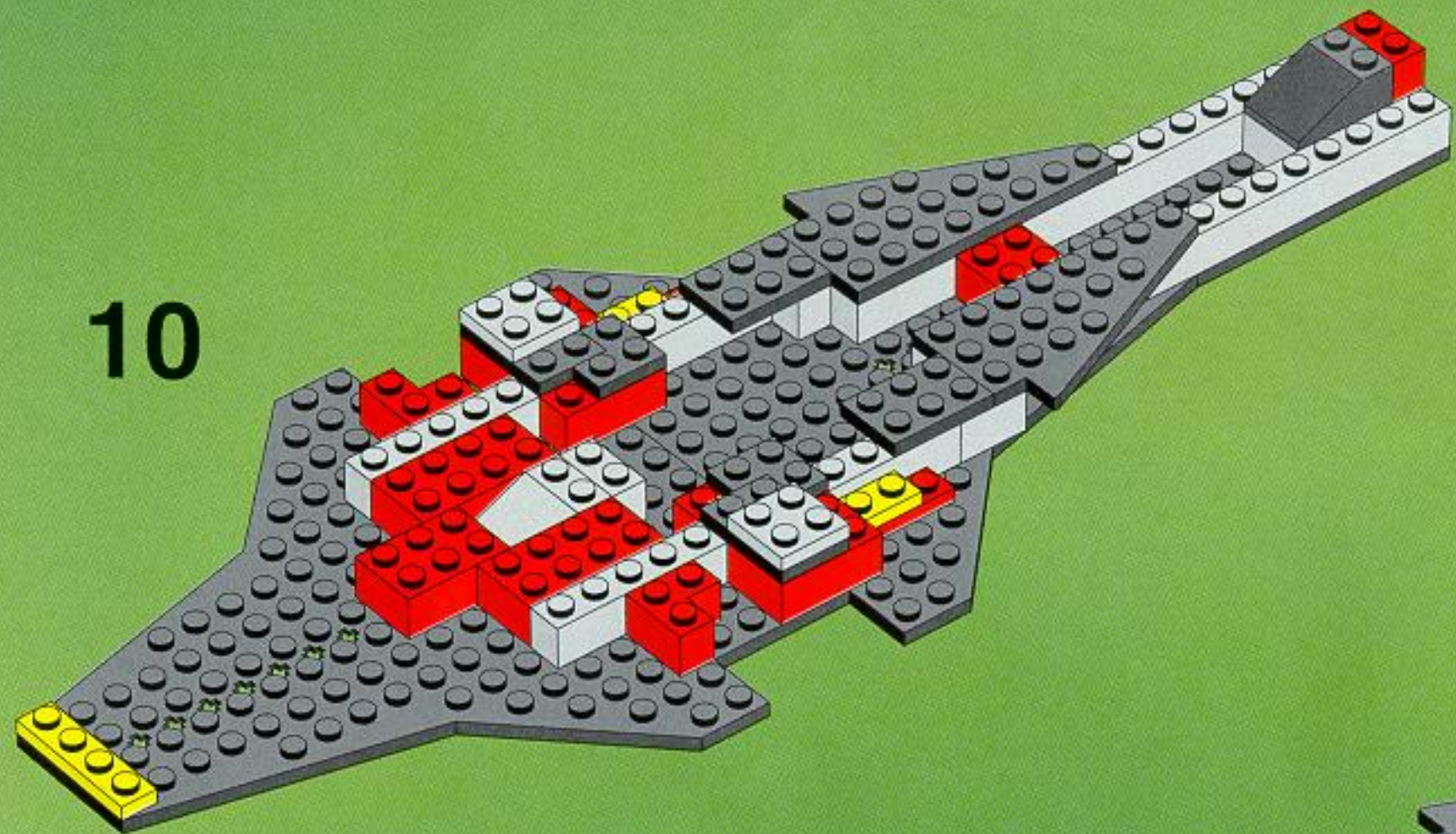

11

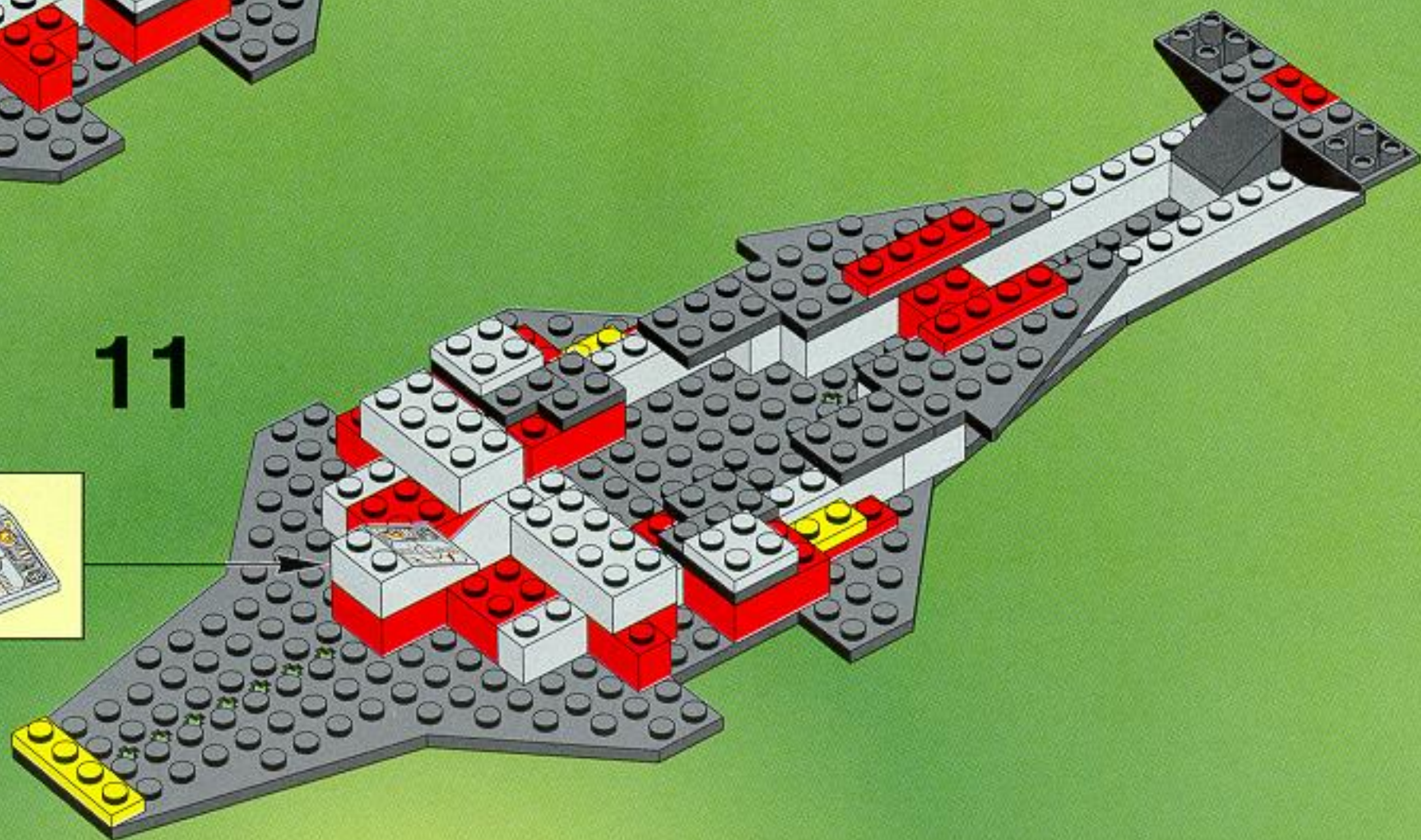

12

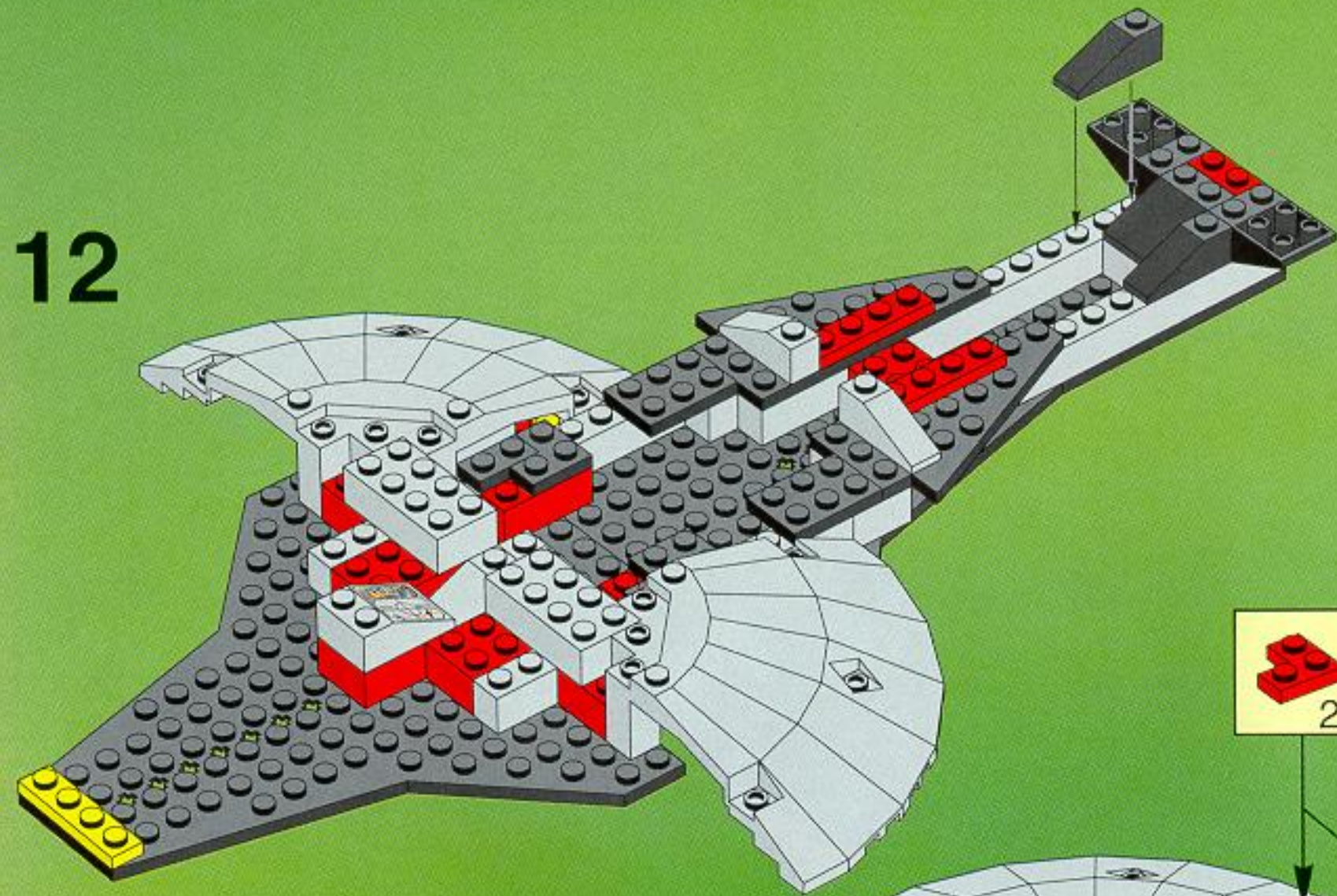

13

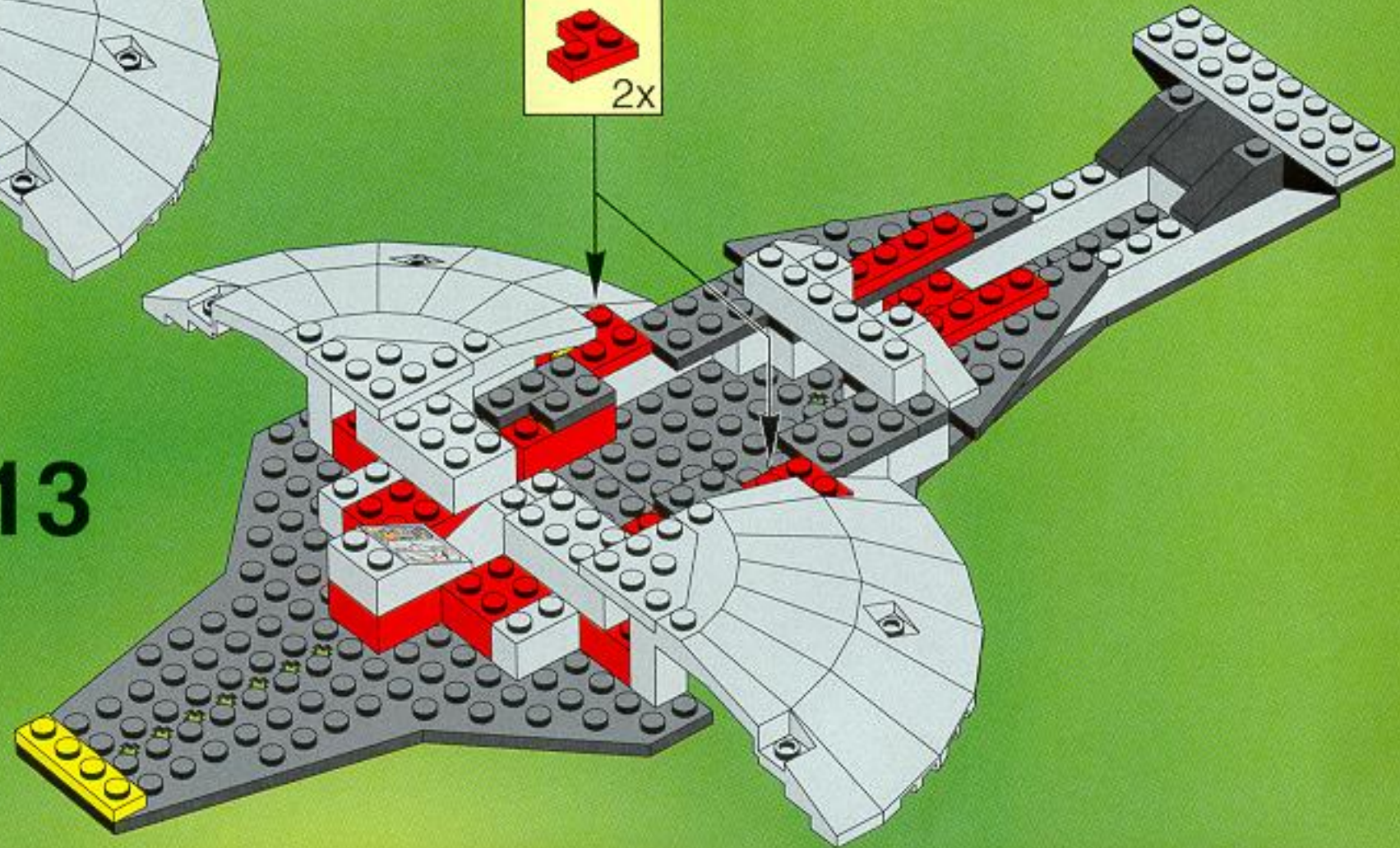

14

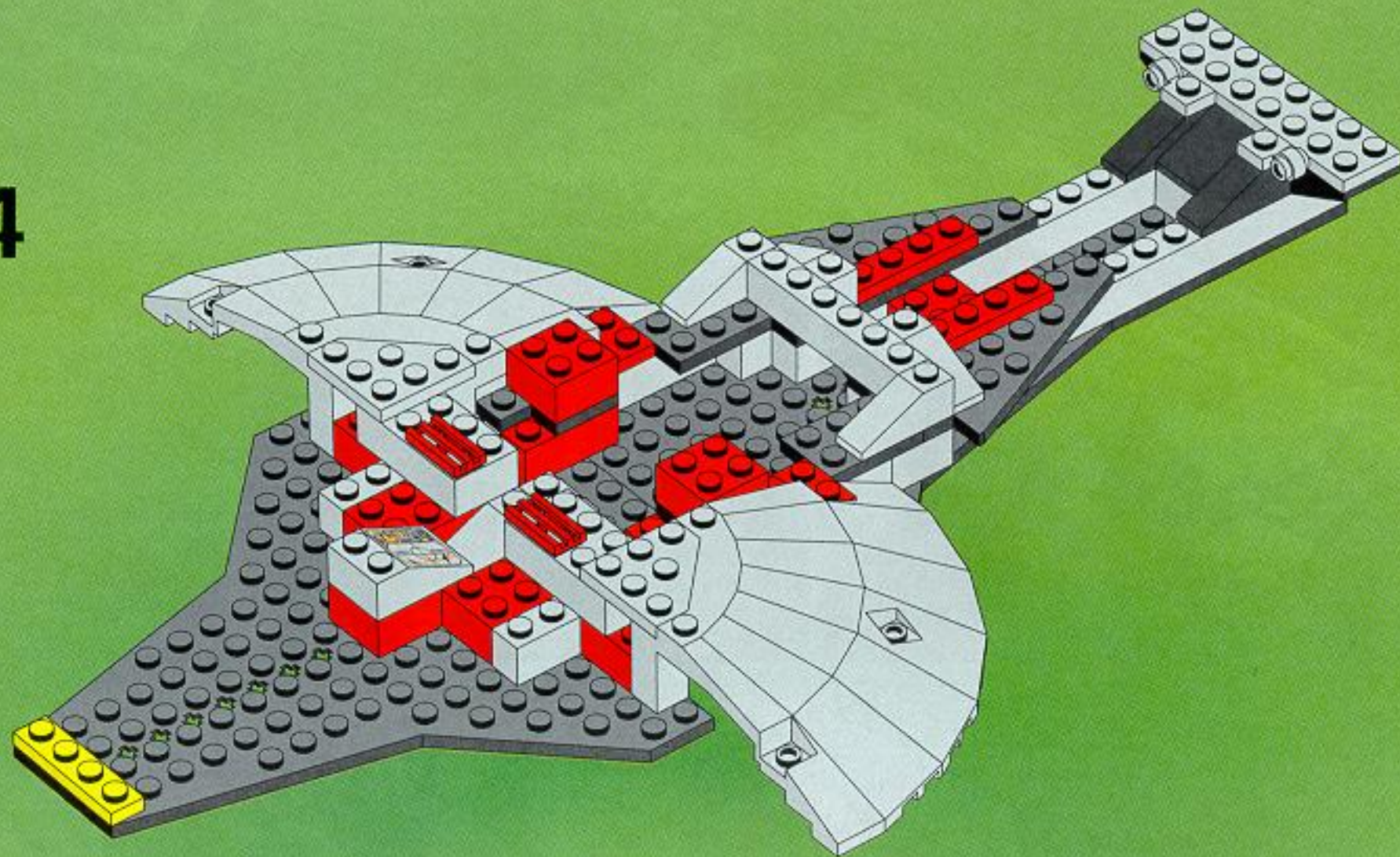

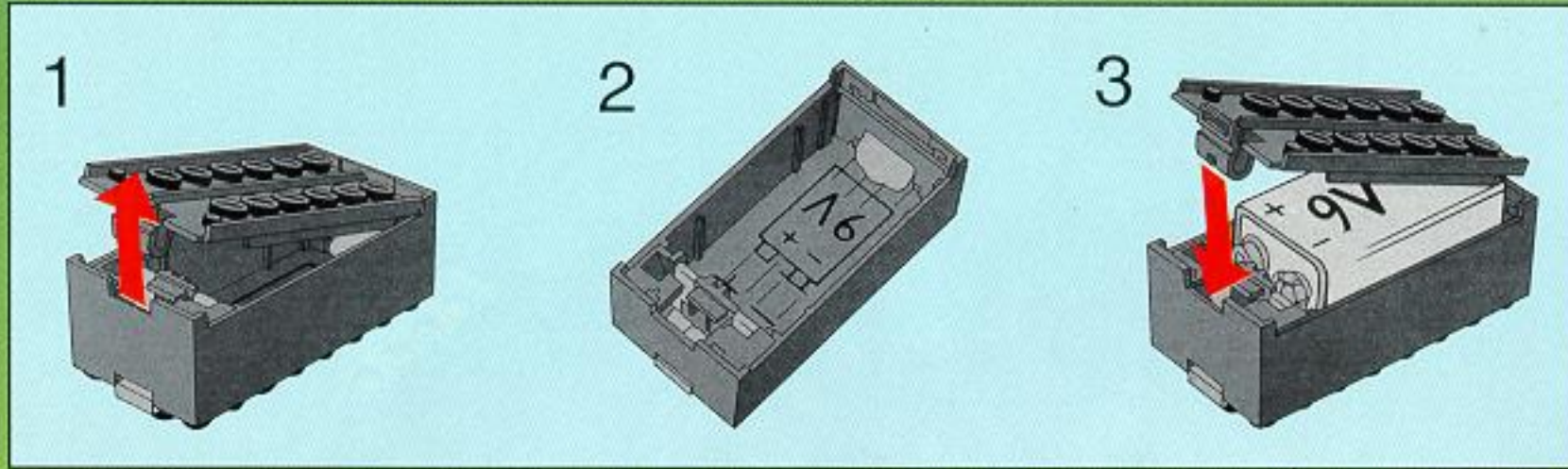

15

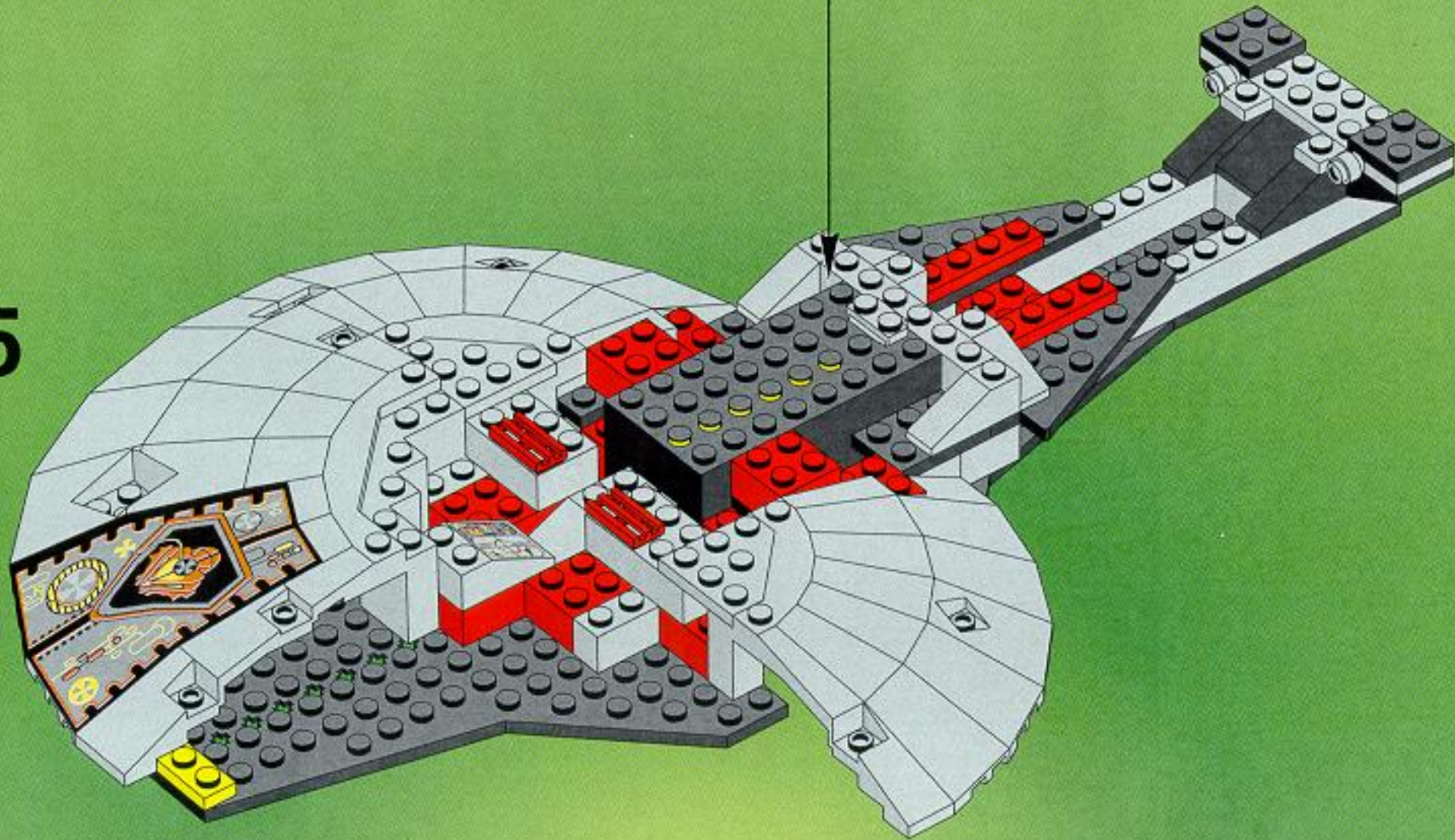

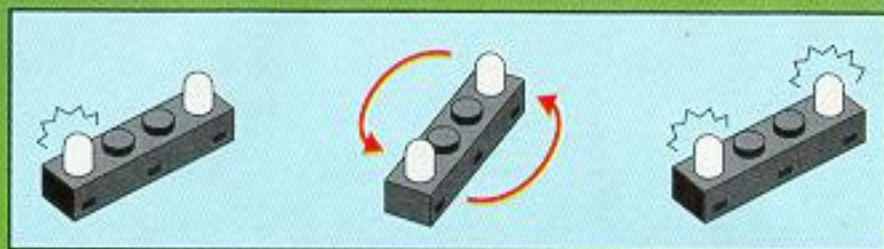

16

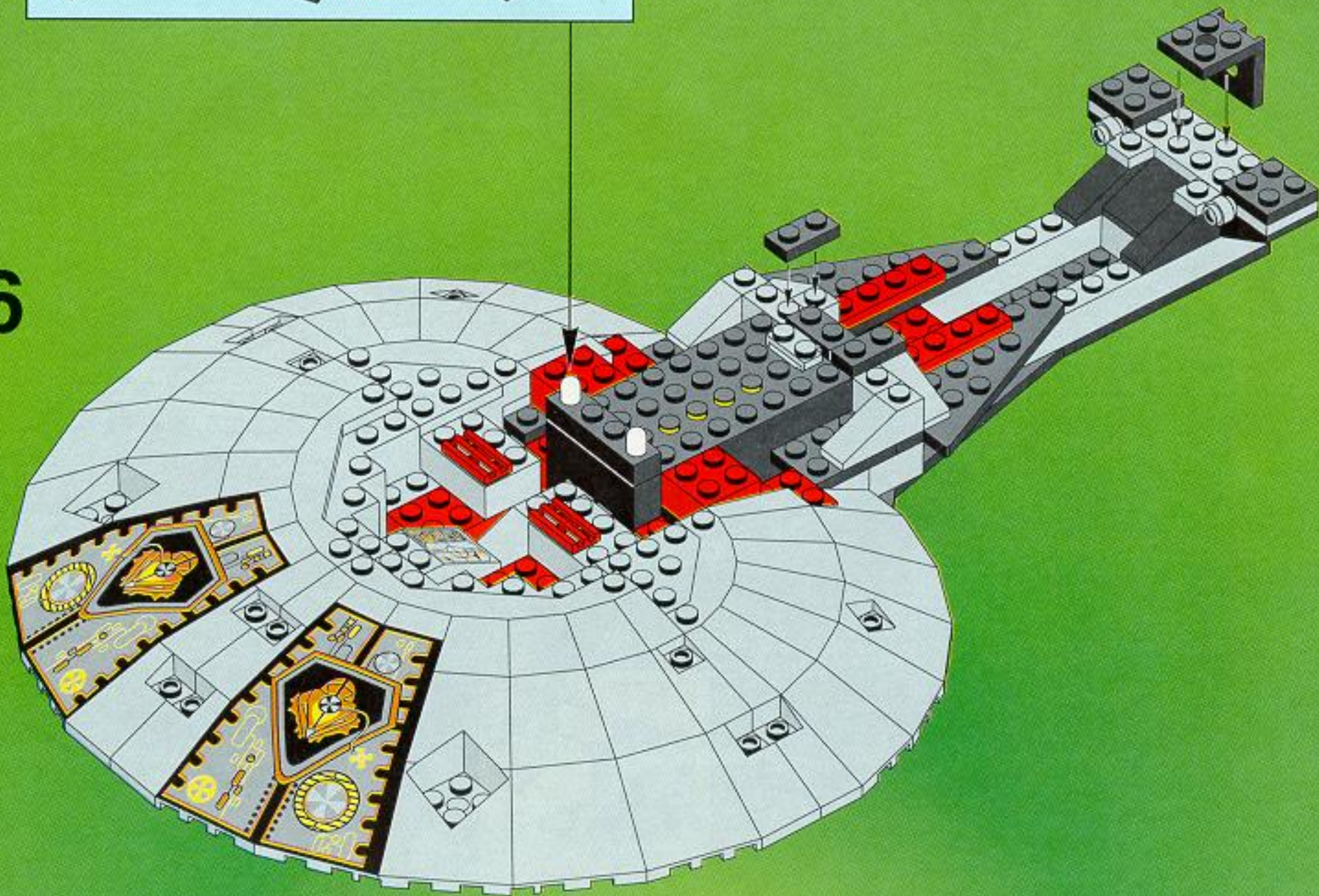

17

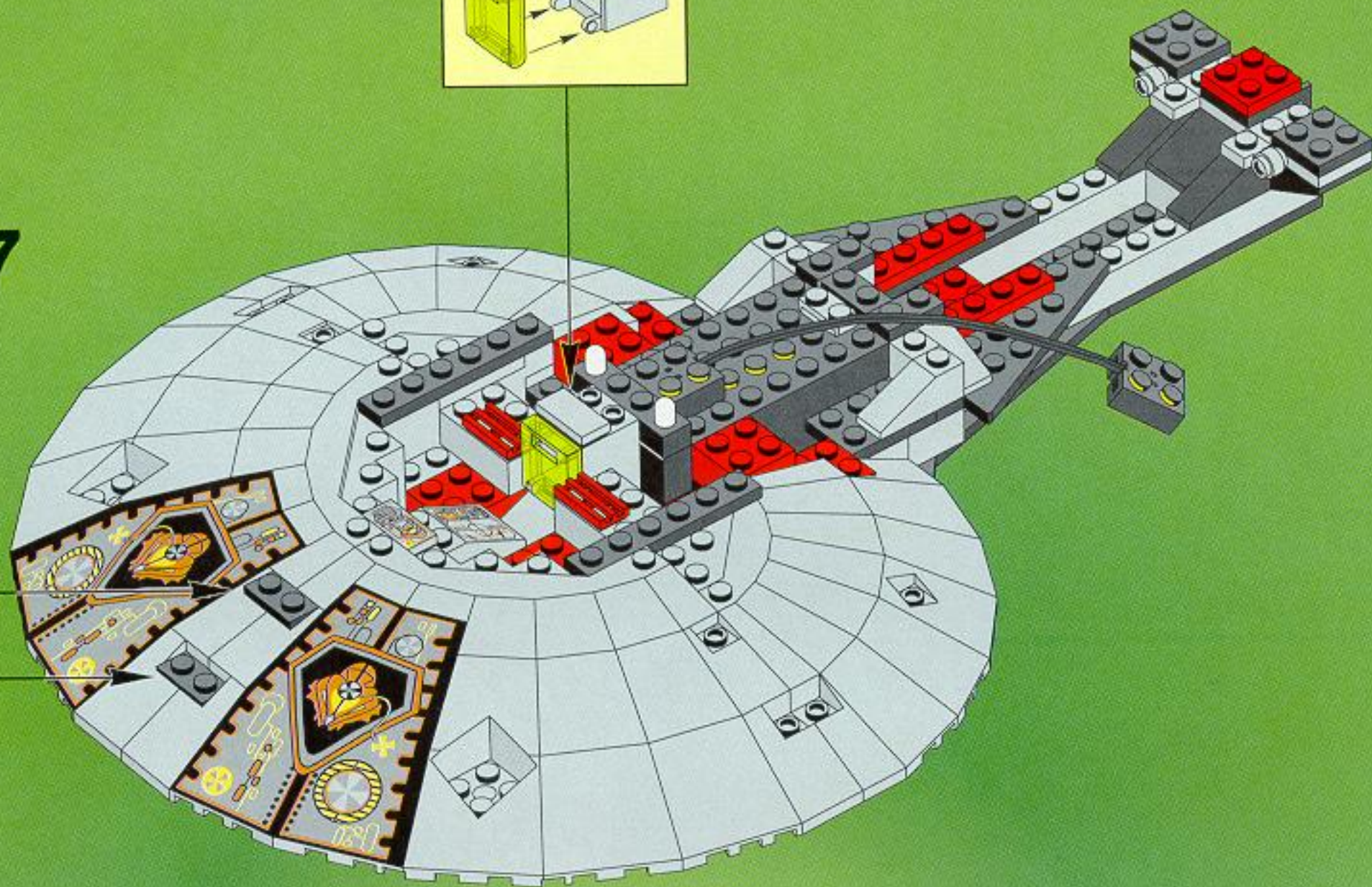
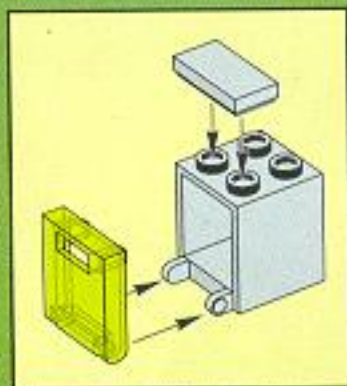

18

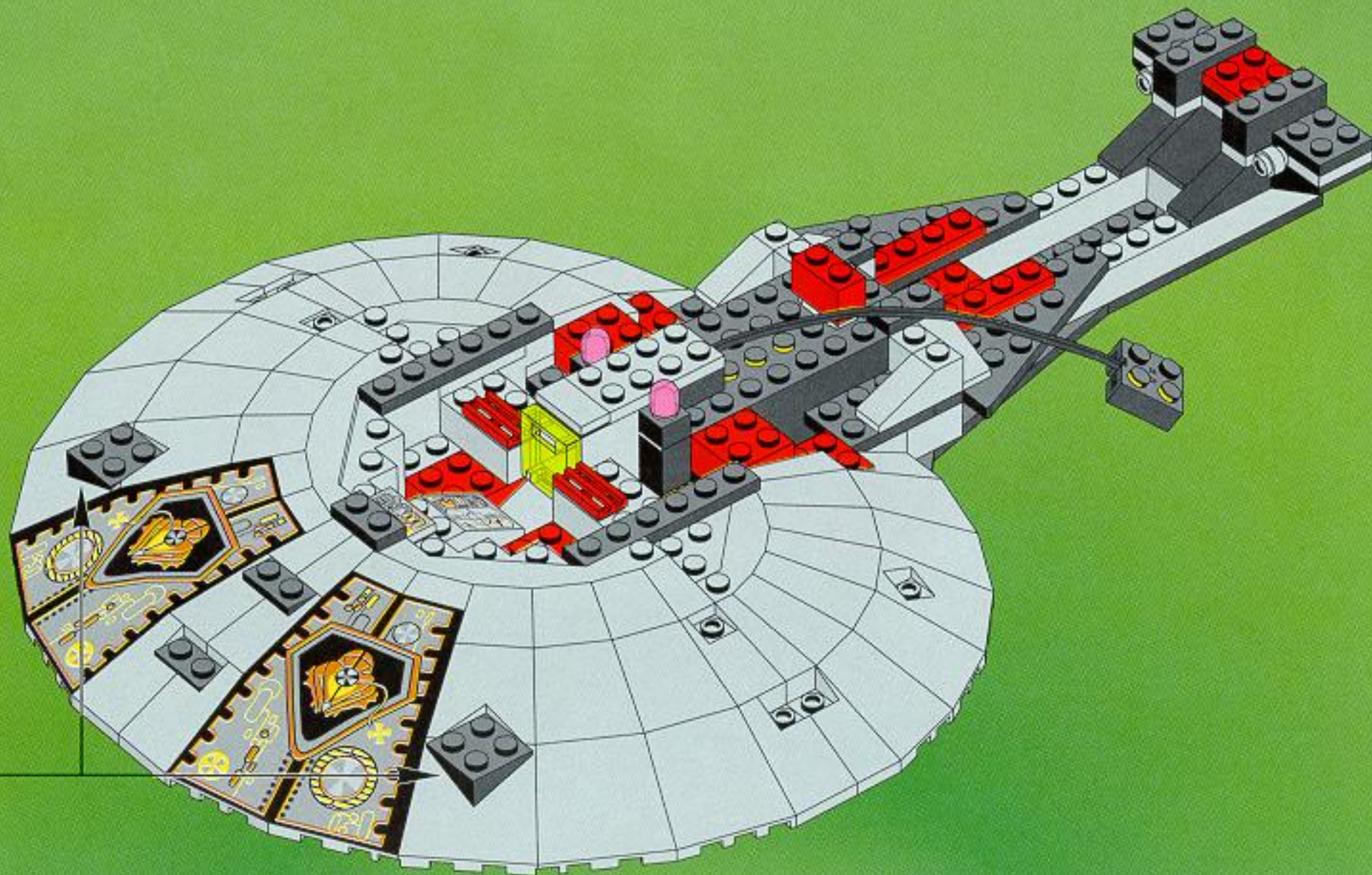

19

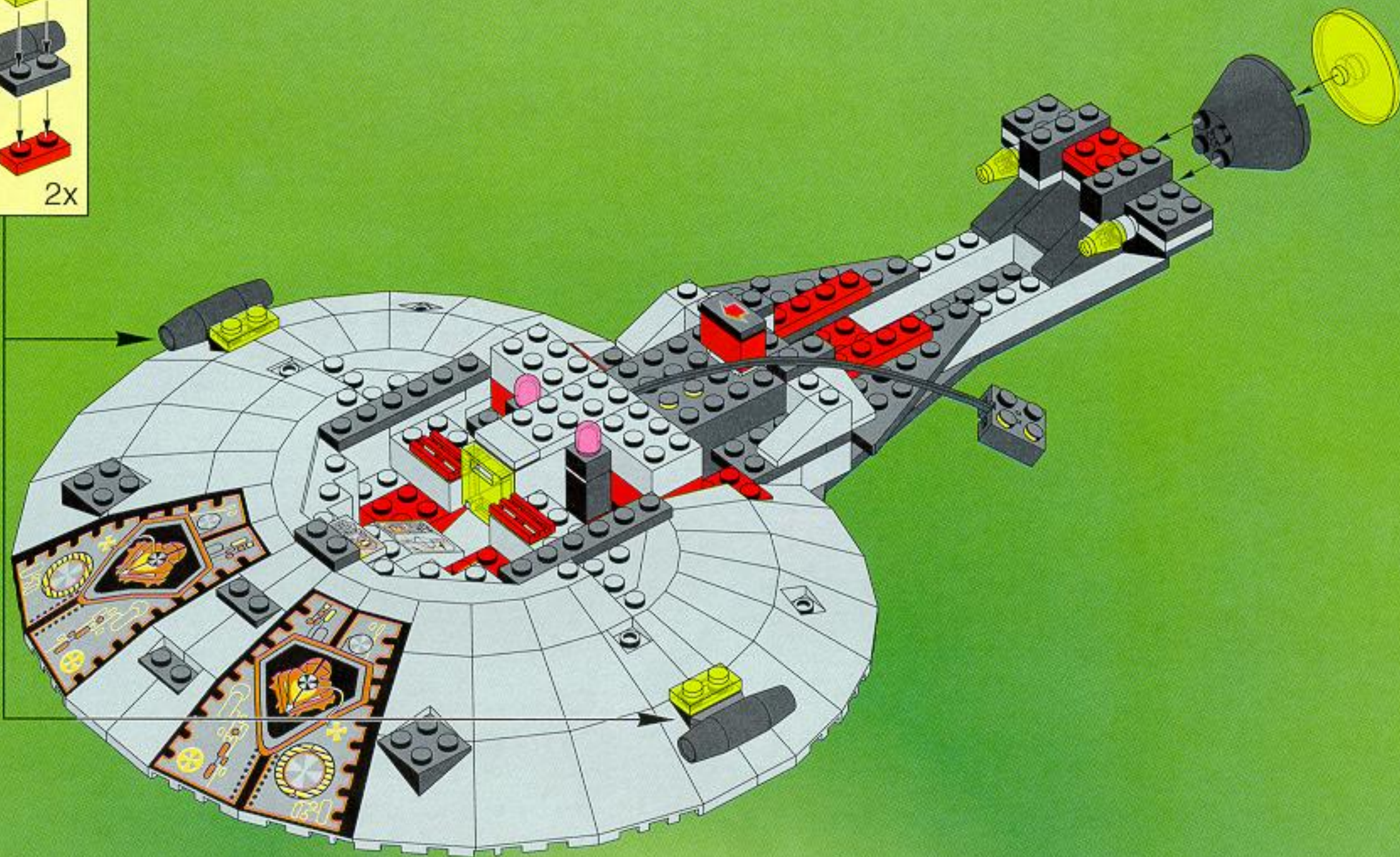
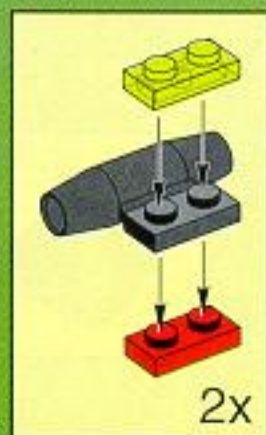

20

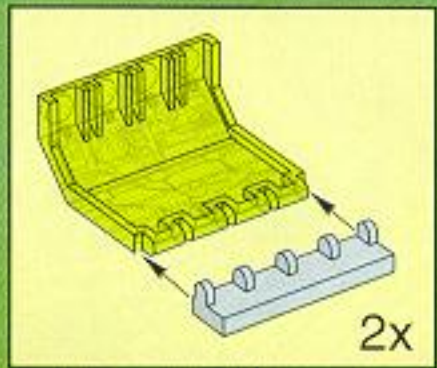

- 1
 - 2
 - 3
- 2x

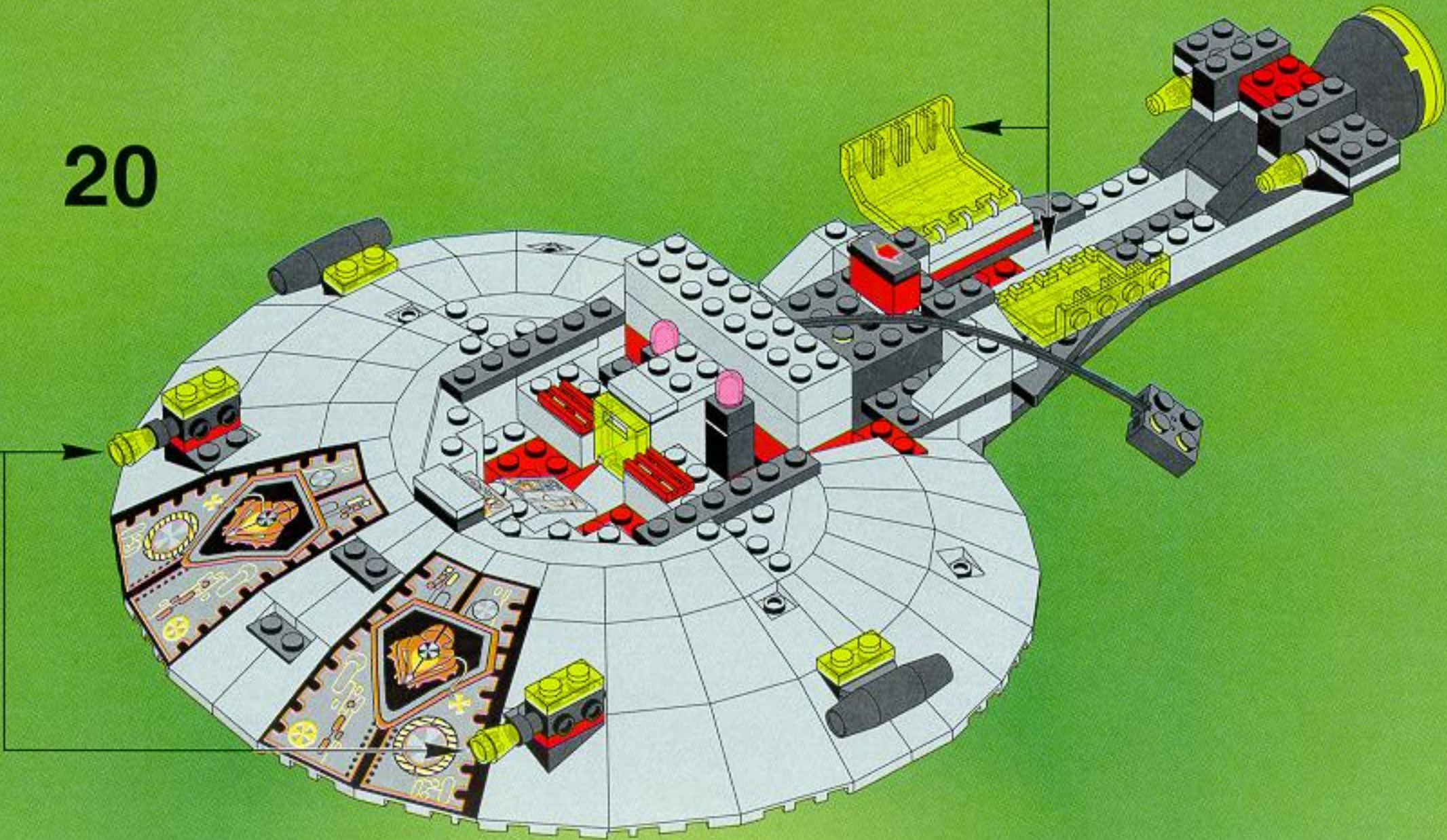

1



2

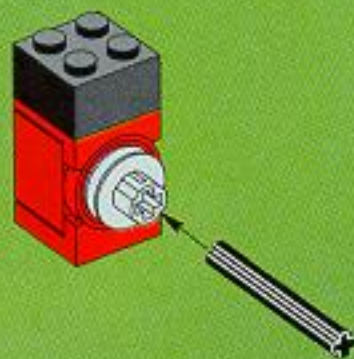

3

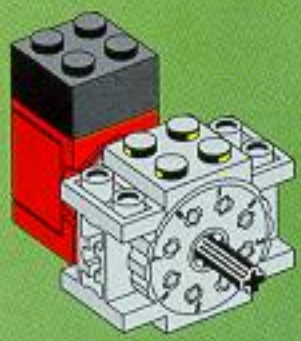

4

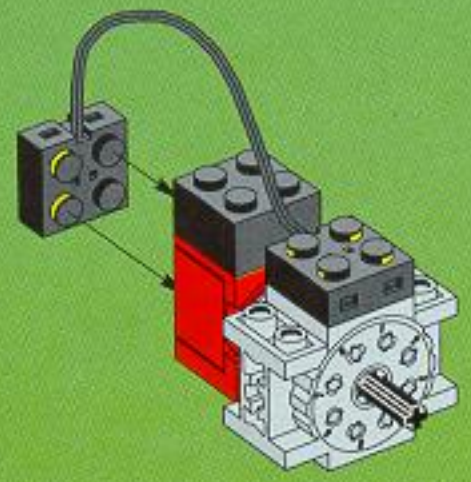

5

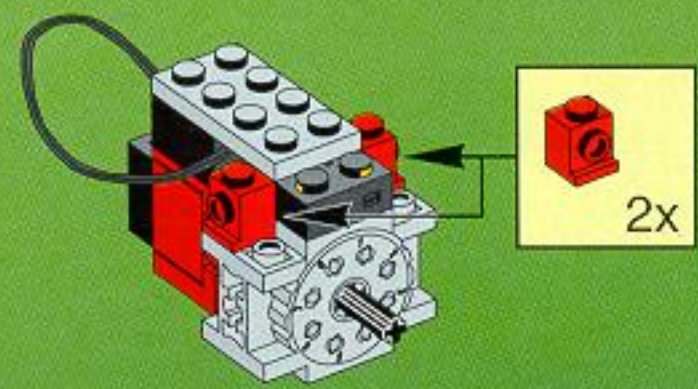

6

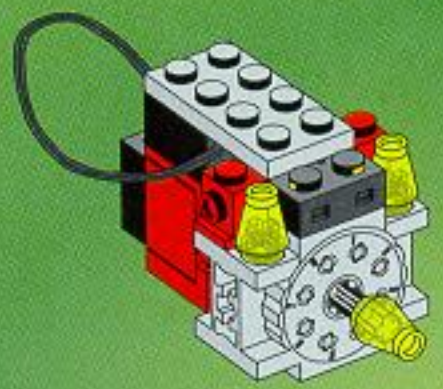

7

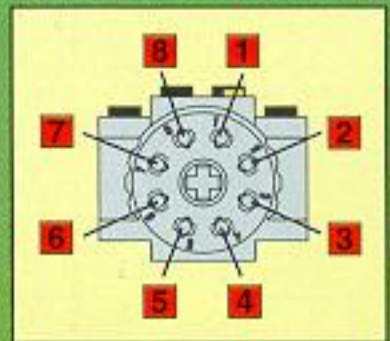
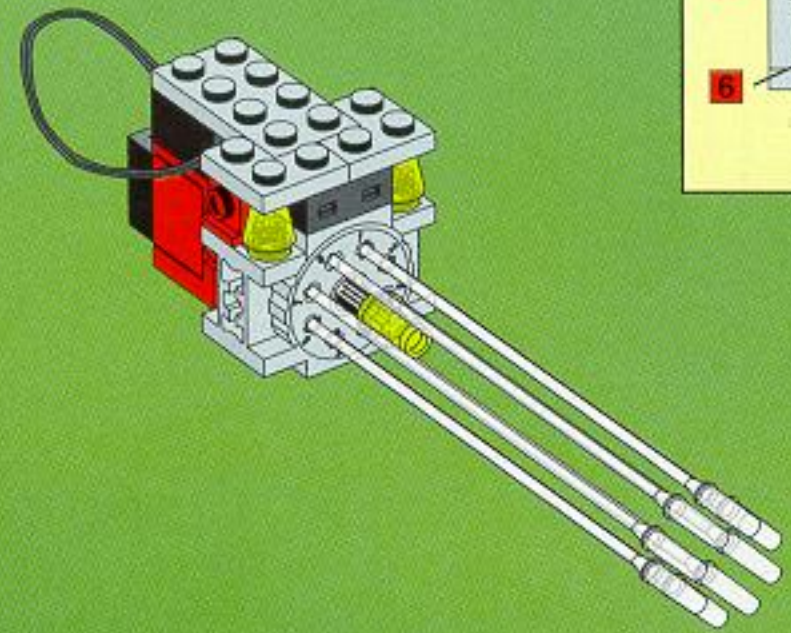

8

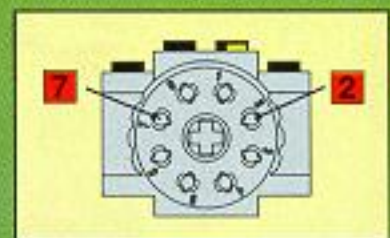
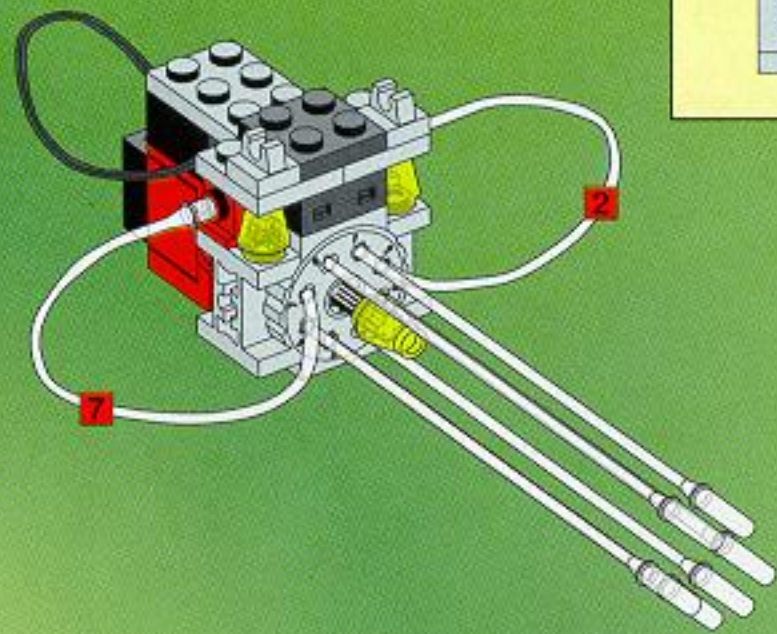

9

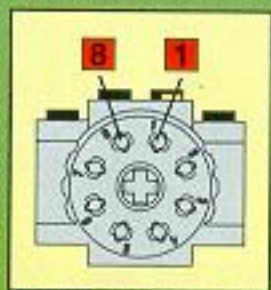
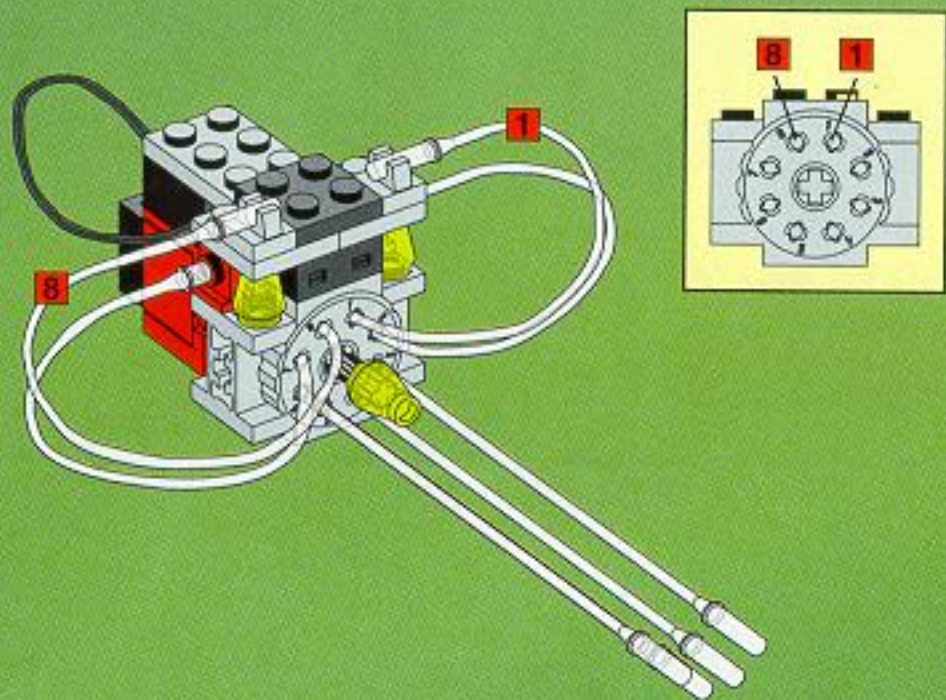

21

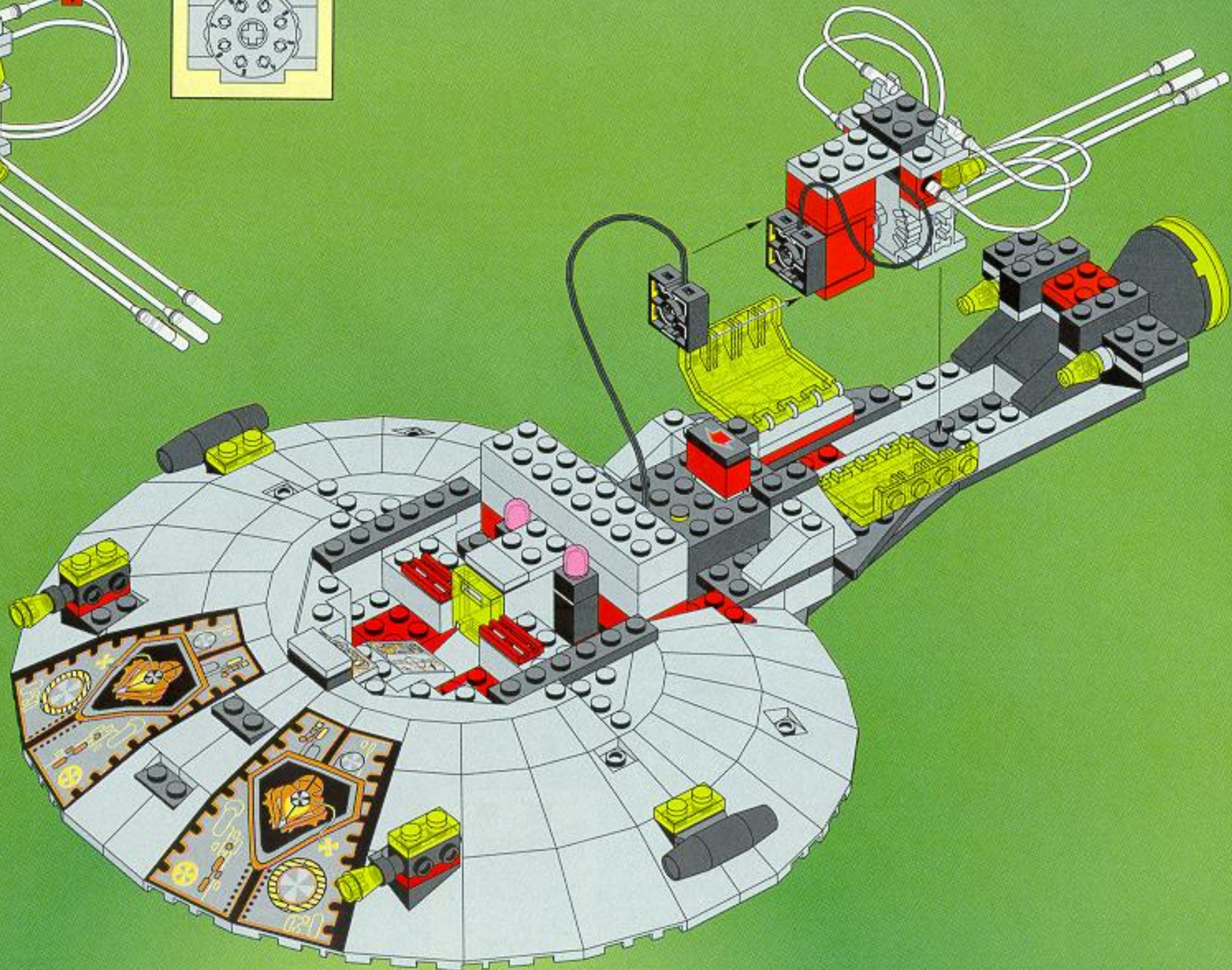

22

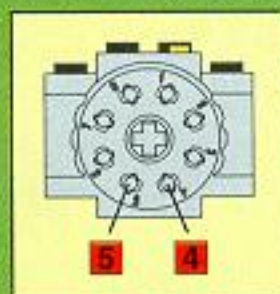
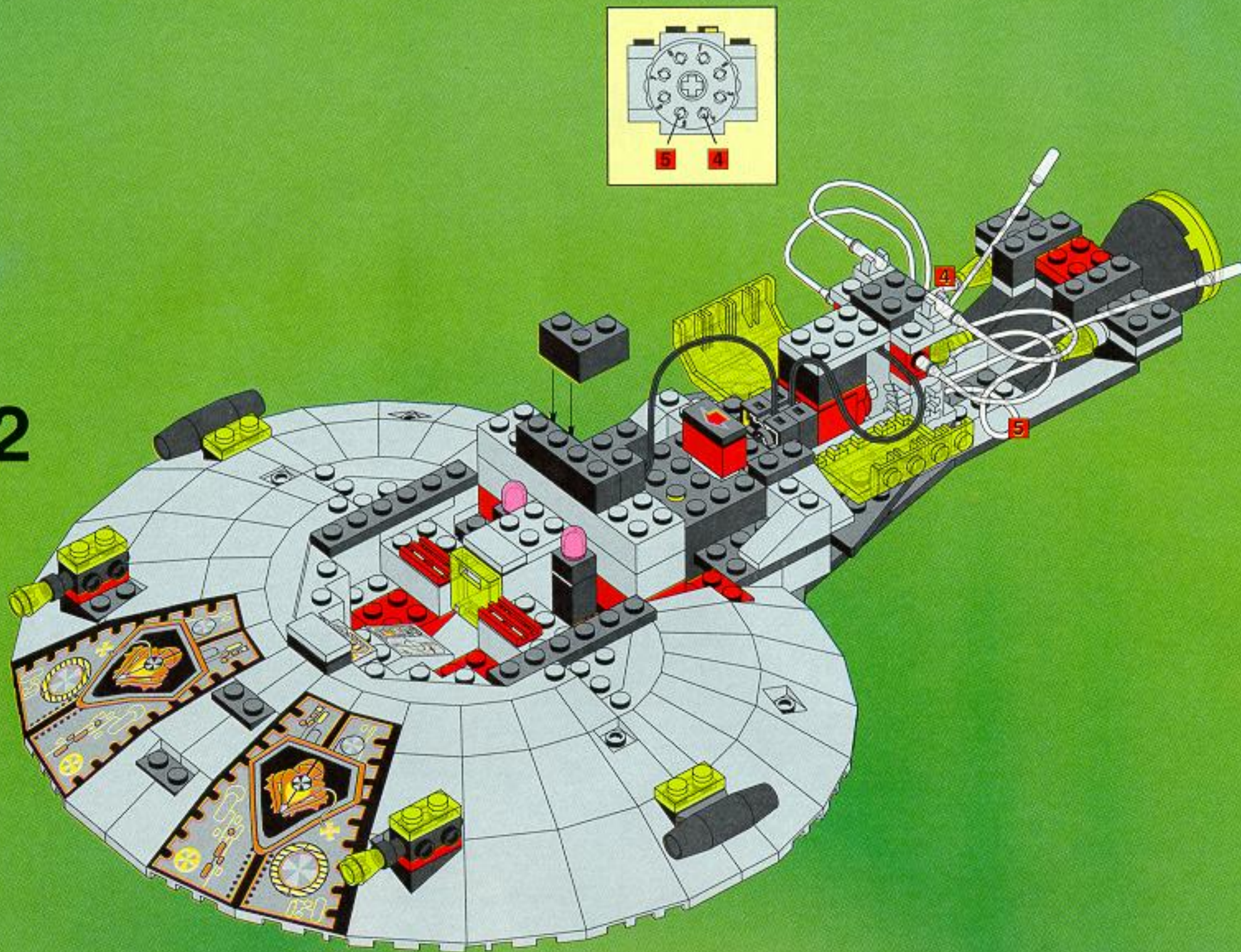

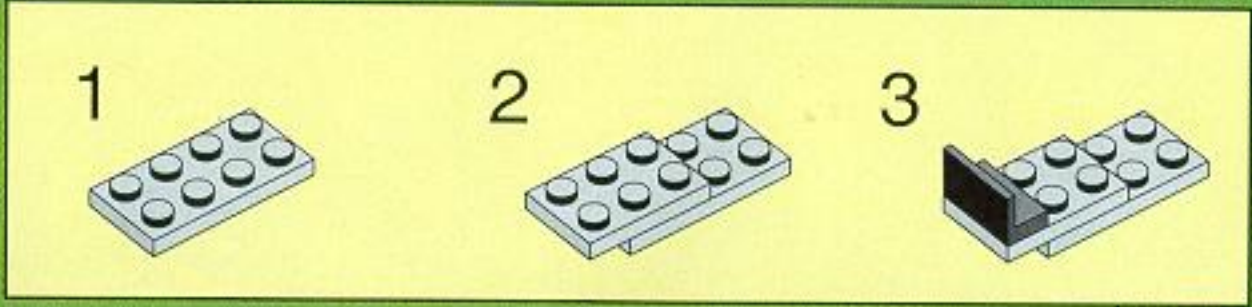

23

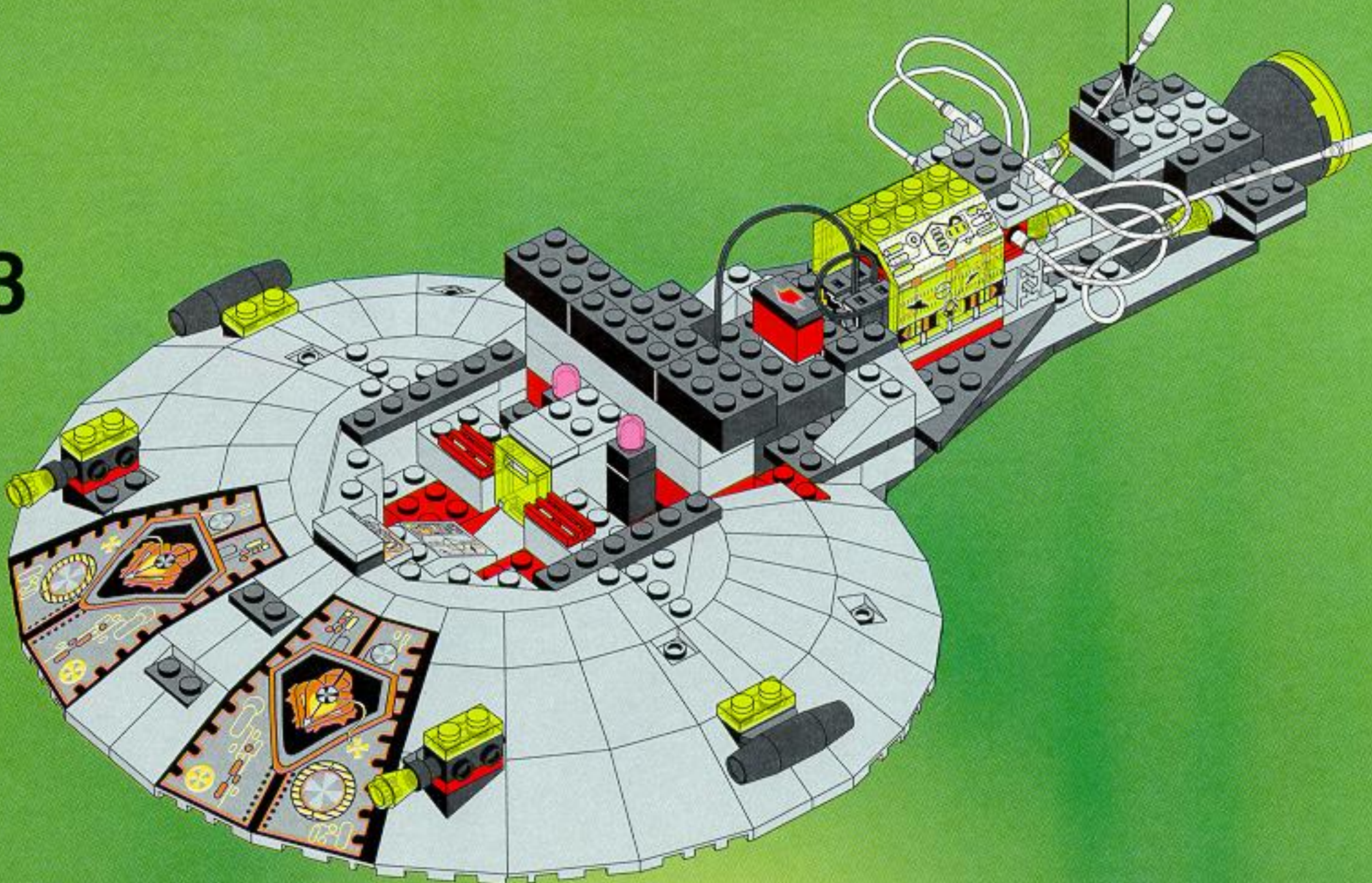

24

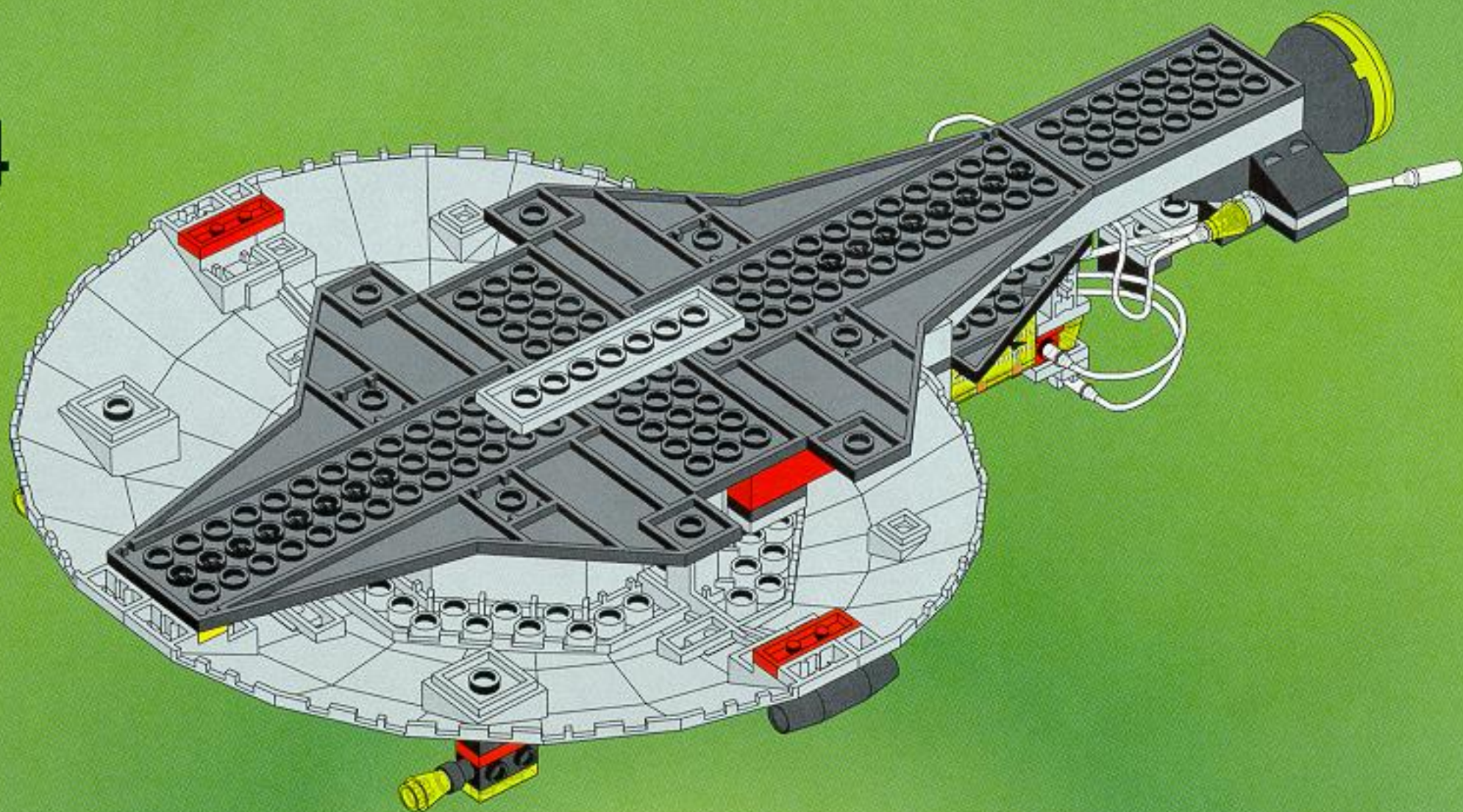

25

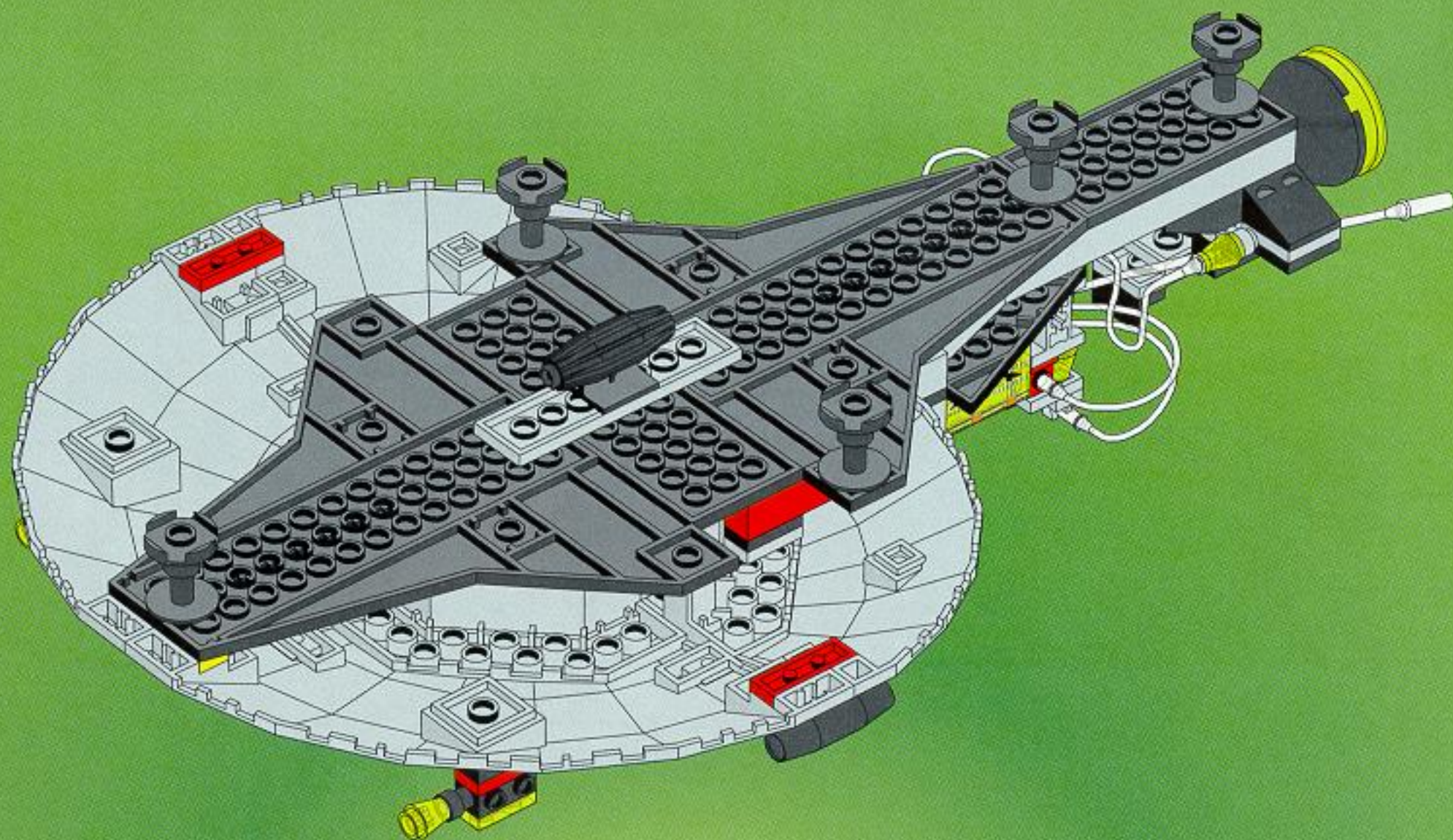

1

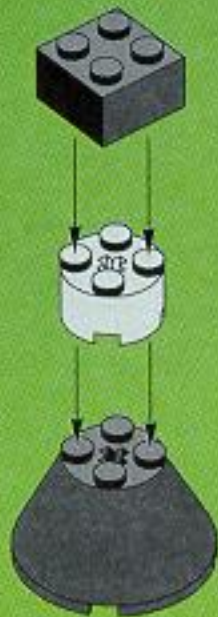

2



3

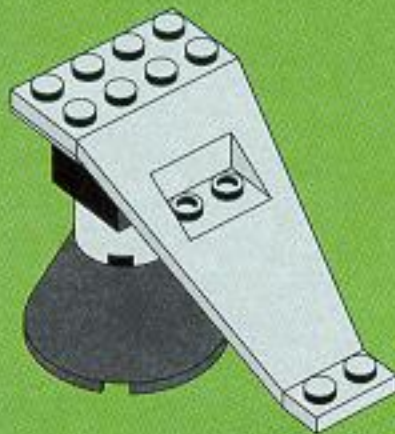

4

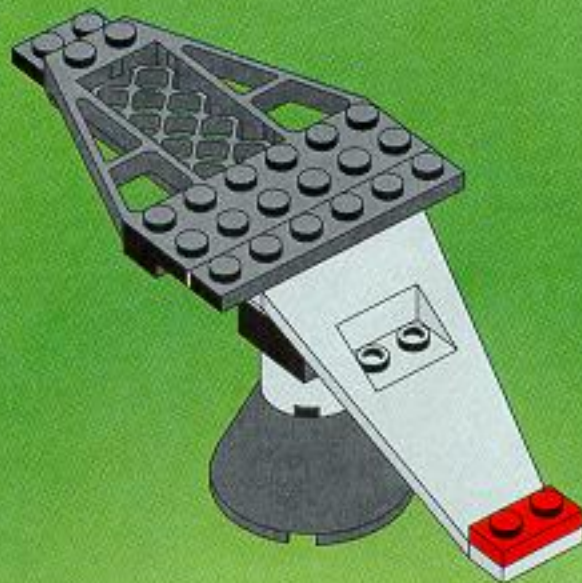

5

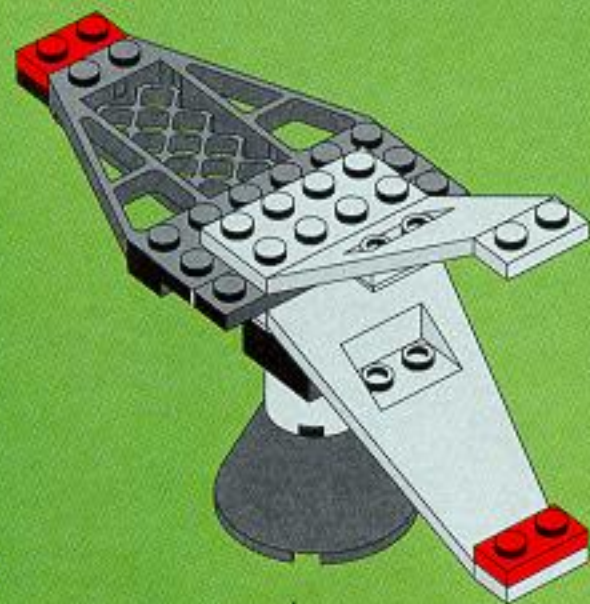

2x

26

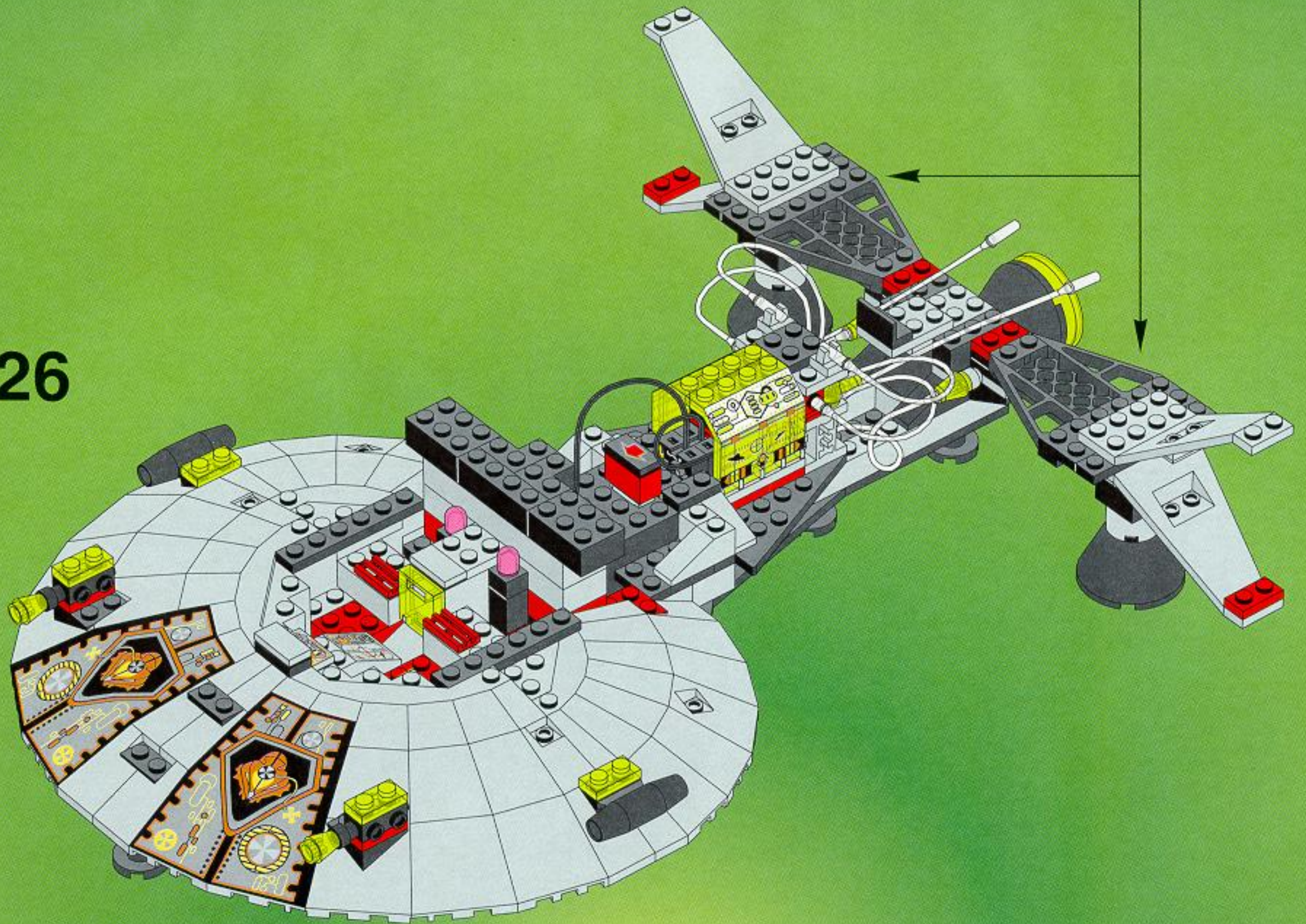

27

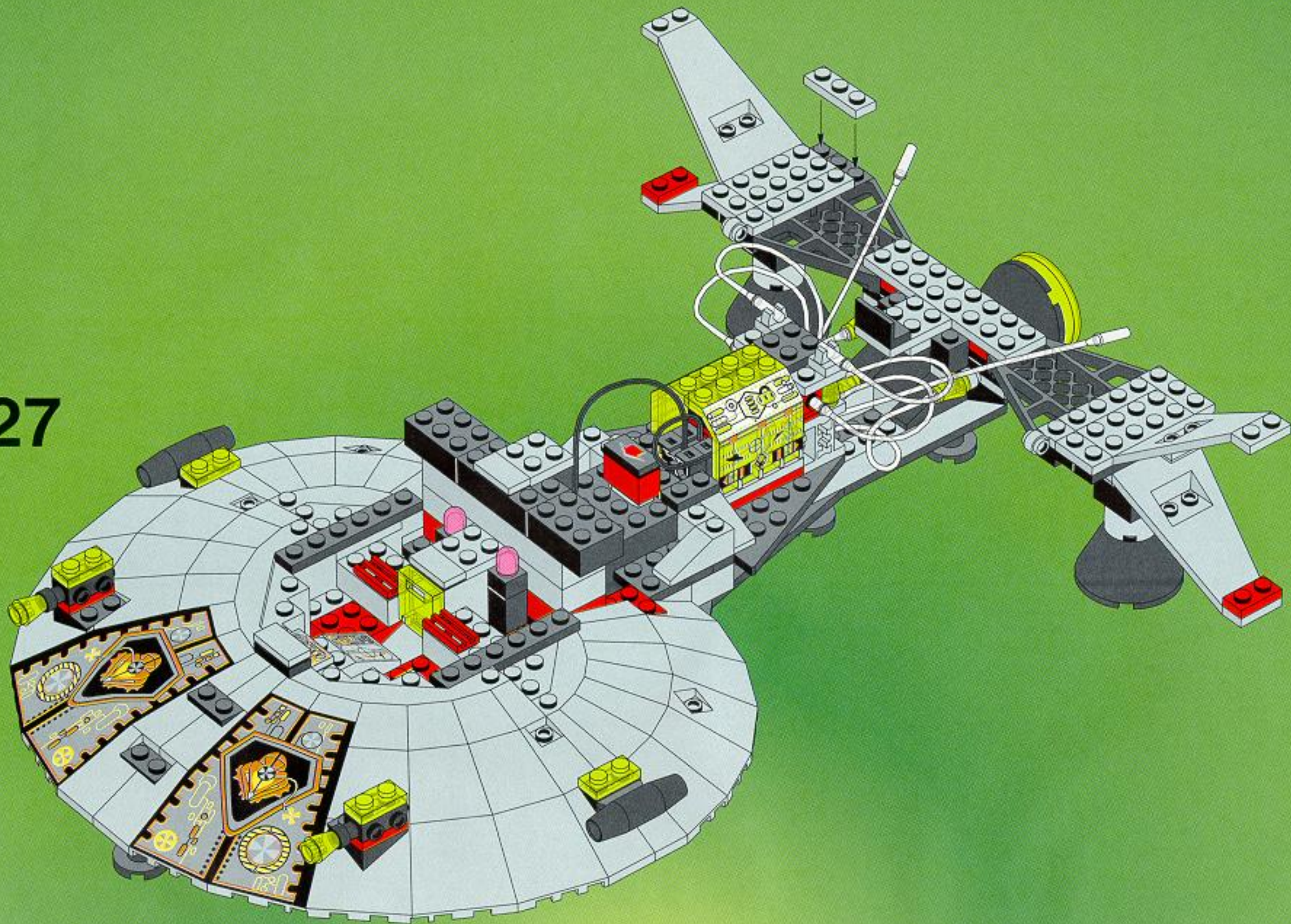

28

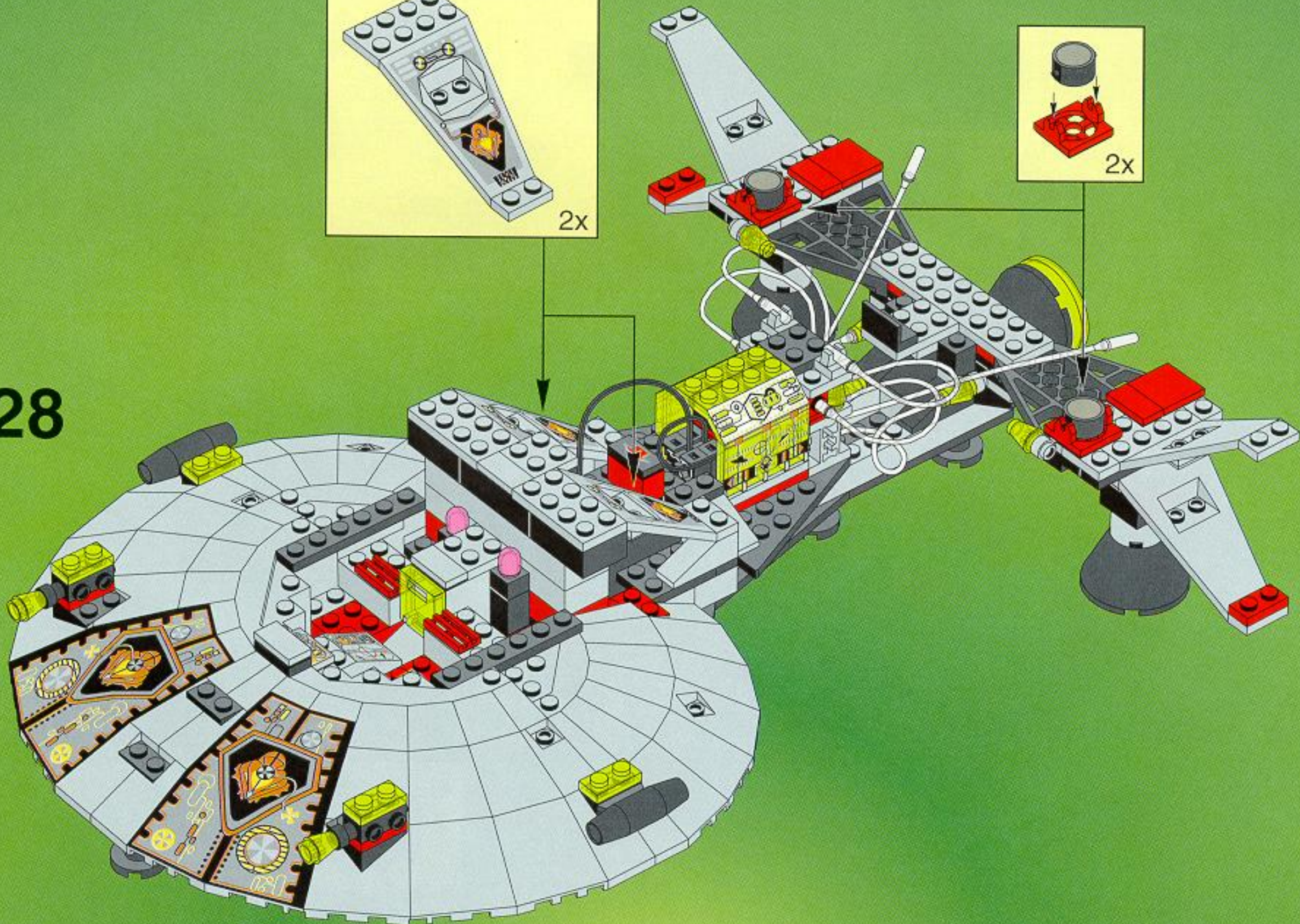
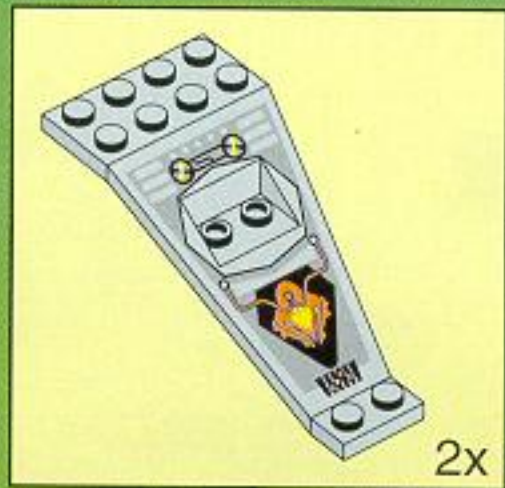

29

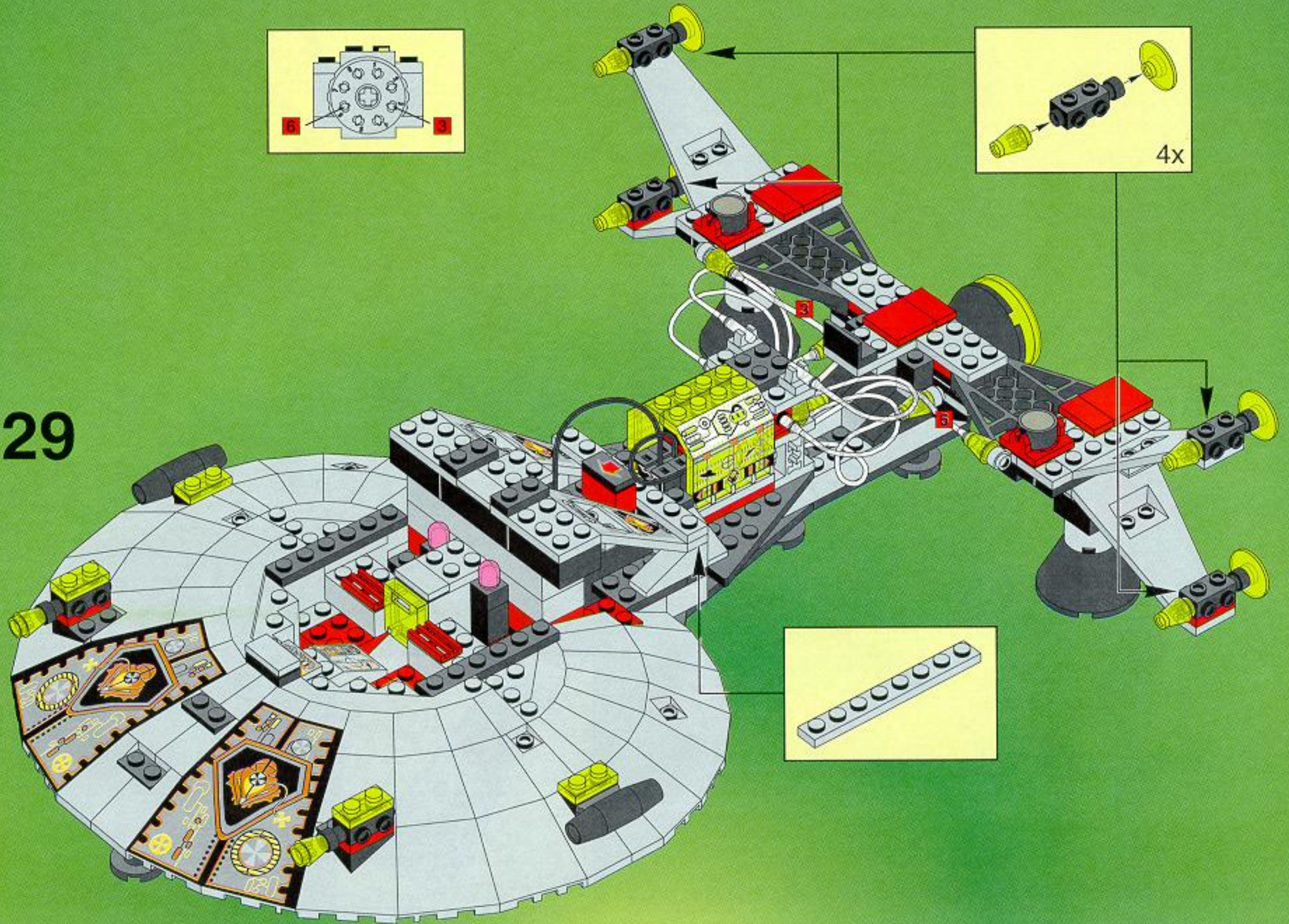

1

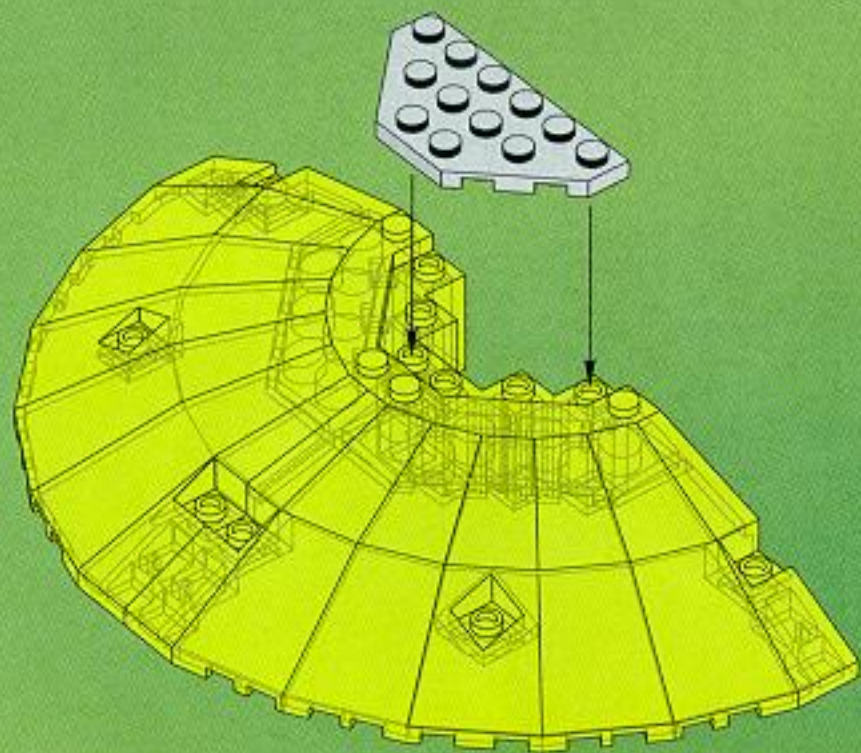

2

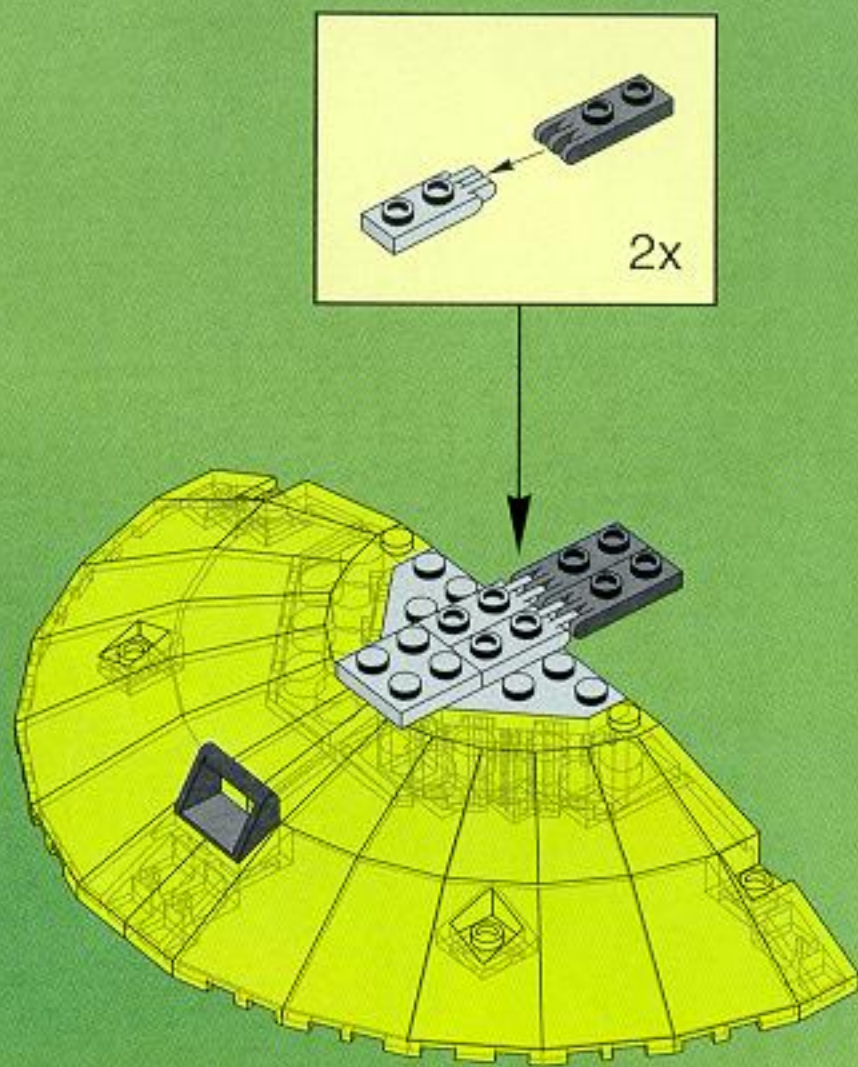

30

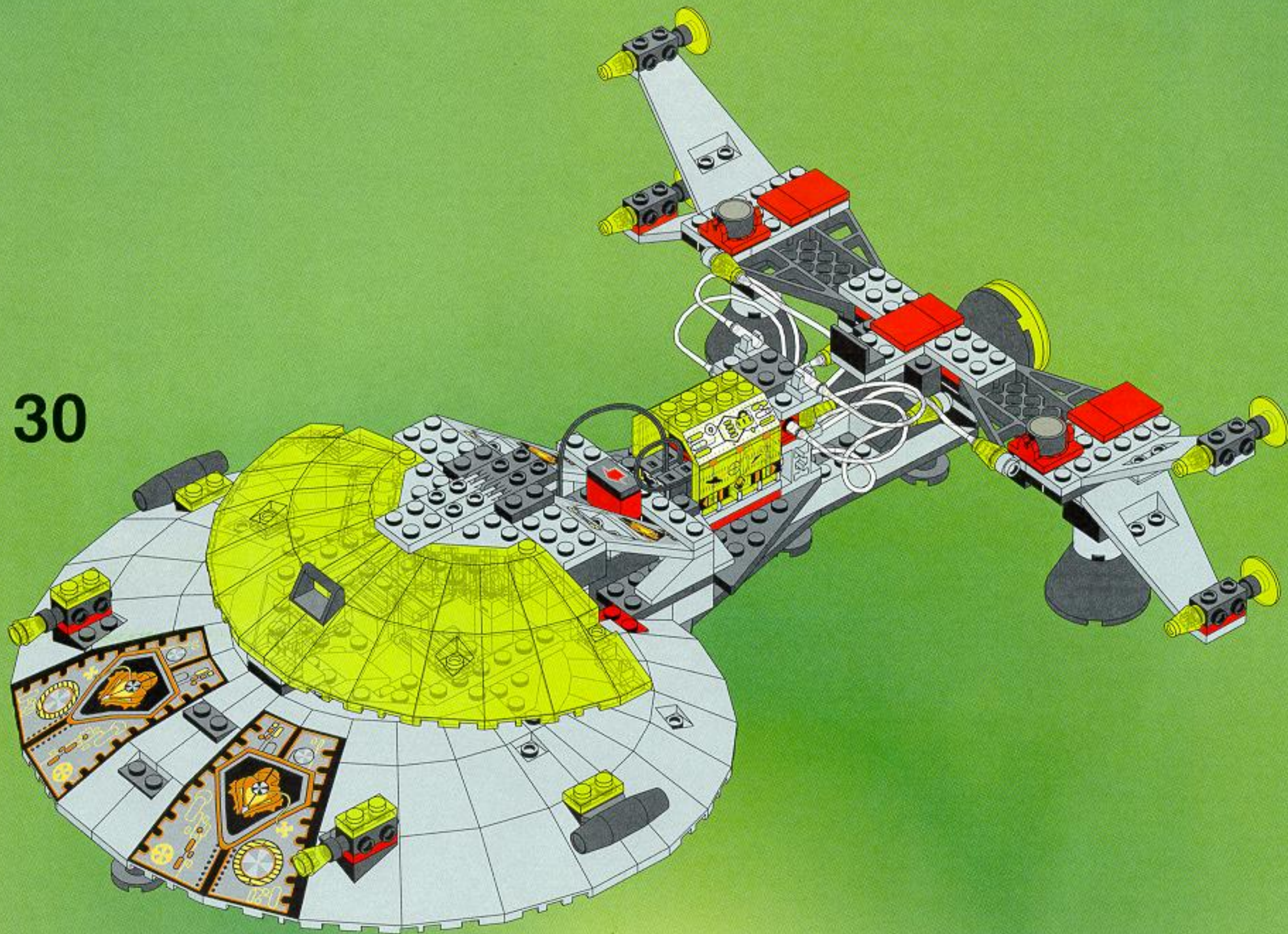

31

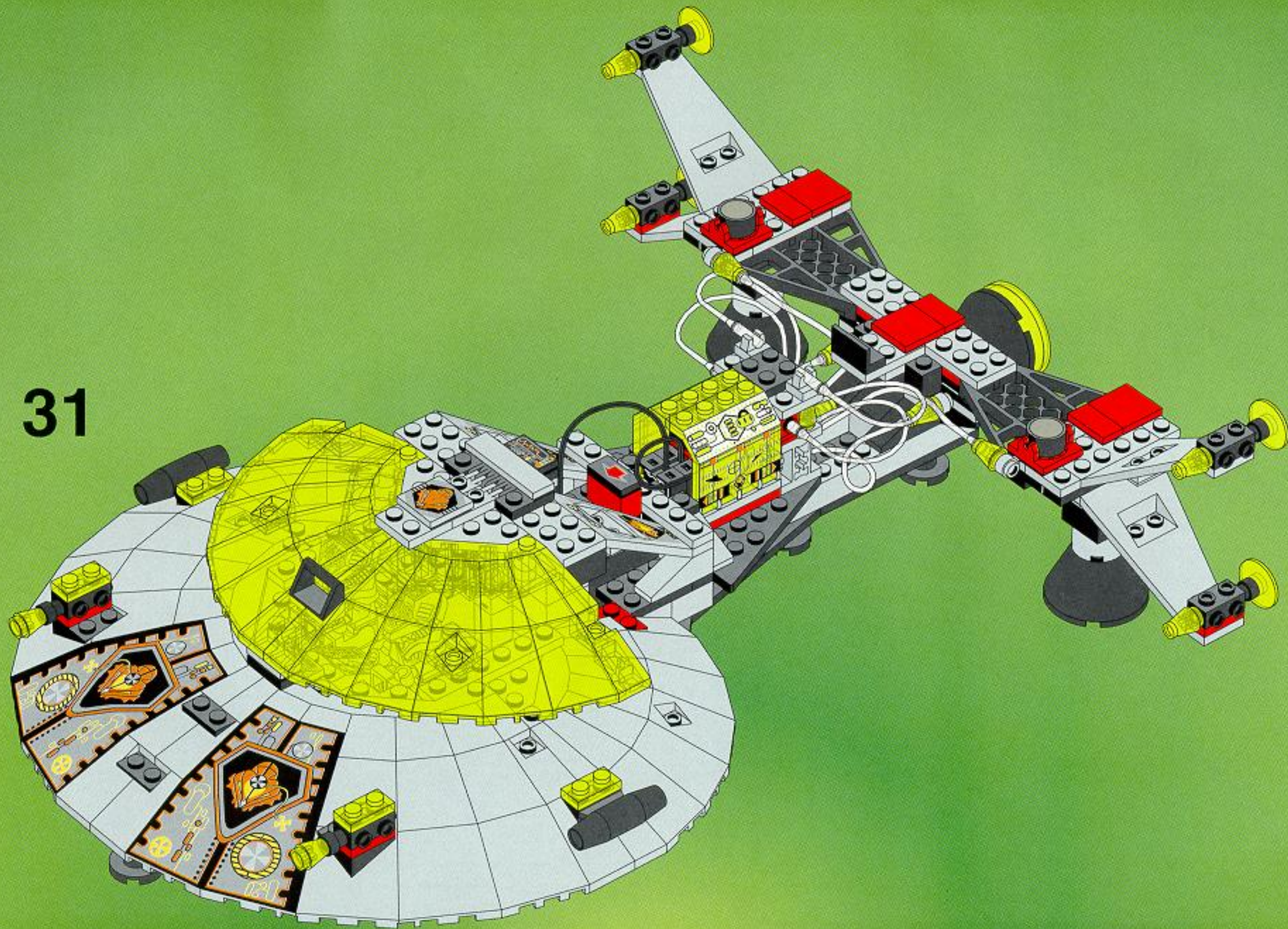



1



2

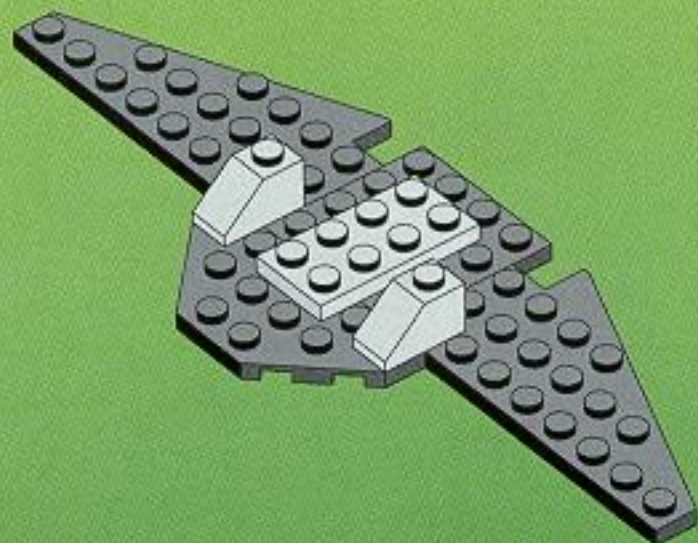

3

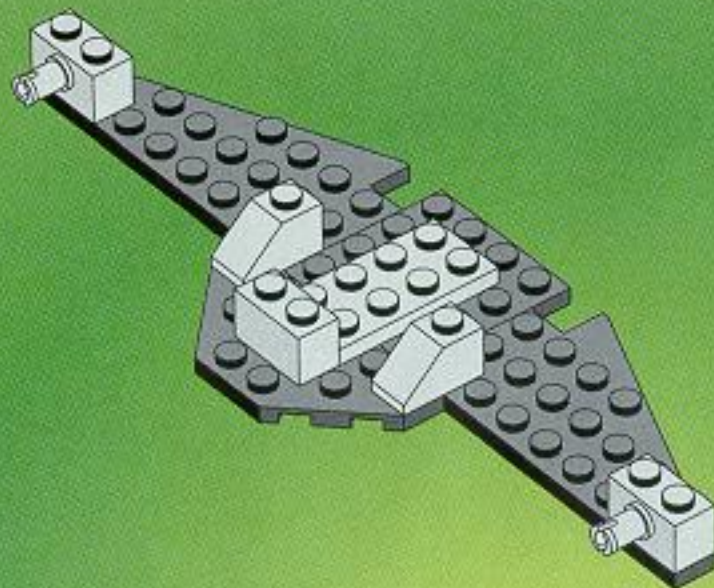

4



5



6

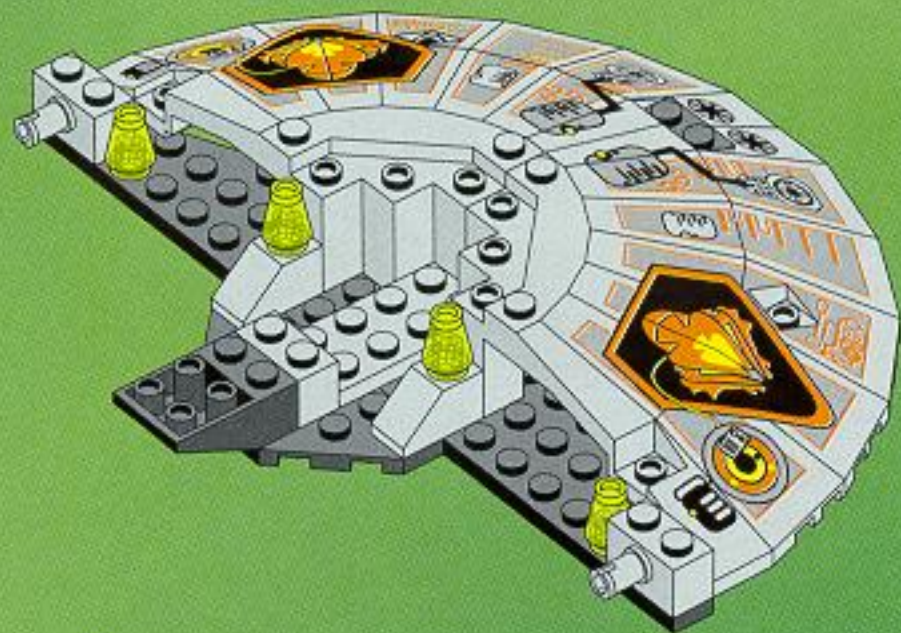

7



8



9



10

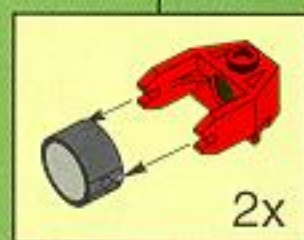
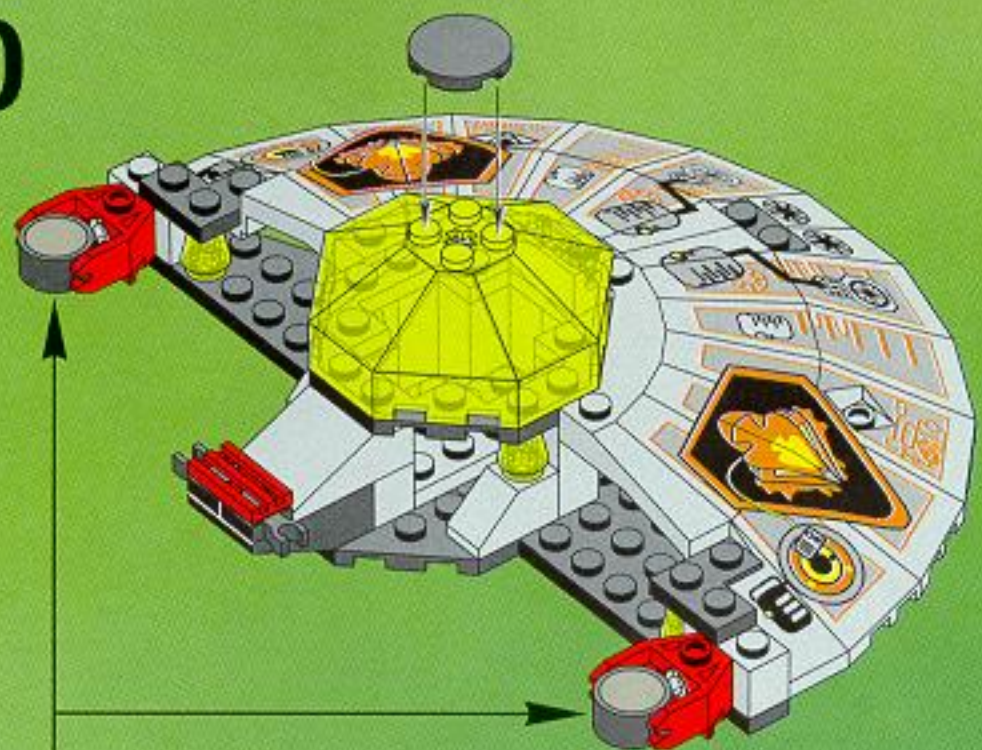

11

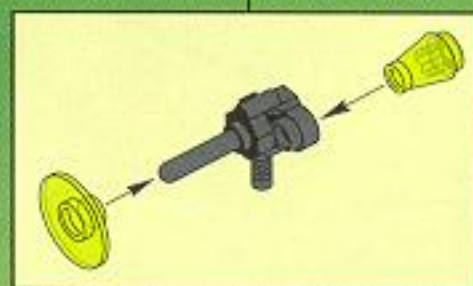

32



**UK** Instructions for use of battery box

Always remove the batteries from the battery box for long-term storage or if they have reached the end of their life. Liquid leaking from dead batteries will damage the battery box. Rechargeable batteries can be used but power may be reduced. Do not recharge the batteries in the battery box.

D Bedienungsanweisung für Batteriekästen

Nimm aufgebrauchte Batterien gleich aus dem Batteriekasten. Lagere den Batteriekasten für längere Zeit stets ohne Batterien. Austretende Flüssigkeit aus alten Batterien kann den Batteriekasten beschädigen. Du kannst wiederaufladbare Batterien benutzen. Aber lade sie nicht im Batteriekasten auf. Entsorge verbrauchte und alte Batterien immer über Sammelstellen. Sie gehören nicht in den Hausmüll!

F Instructions pour l'utilisation du boîtier-piles

Pensez à enlever les piles du boîtier lorsque vous ne vous en servez pas, et ne les gardez pas trop longtemps, car le liquide provenant de piles usagées peut endommager le boîtier. Vous pouvez utiliser des piles rechargeables, mais ne les rechargez pas dans le boîtier-piles.

I Istruzioni per l'uso del portapile

Togliere sempre le pile se scariche o se non devono essere utilizzate per lungo tempo. Il liquido che fuoriesce dalle pile scariche danneggia il portapile. E' possibile utilizzare pile ricaricabili. Non ricaricare le pile nel portapile.

NL Zo gebruikt u de batterijhouder

Als u de batterijhouder langere tijd niet gebruikt, verwijdert u dan de batterijen. Dit geldt ook voor batterijen die leeg zijn. Batterijen die leeg zijn of die lang in de batterijhouder zitten kunnen gaan lekken. Dit veroorzaakt onherstelbare schade en valt niet onder garantie. U kunt oplaadbare batterijen gebruiken. Laad nooit batterijen op in de batterijhouder.

E Instrucciones para el uso del porta-pilas

Sacar siempre las pilas de la caja porta-pilas cuando no vayan a utilizarse por un tiempo y cambiarlas igualmente cuando estén muy usadas, ya que el líquido que desprenden puede dañar las conexiones de la caja porta-pilas. Pueden utilizarse pilas recargables, si bien no deben recargarse dentro de la caja porta-pilas.

DK Batteriinformation

Tag altid batterierne ud af batteriboksen, hvis du ikke skal bruge den i længere tid, eller hvis batterierne er brugt op. Væske fra batterierne kan ødelægge batteriboksen. Man kan anvende genopladelige batterier. Genoplad aldrig batterierne i batteriboksen.

FIN Paristokotelon käyttöohje

Poistakaa paristot aina paristokotelosta mikäli ne ovat loppuunkäytetyt tai mikäli ette käytä paristokoteloita pitkään aikaan. Nestevuodot loppuunkäytetyistä paristoista vahingoittavat paristokoteloita. Voitte käyttää myös akkuja. Älkää kuitenkaan ladaako akkuja paristokotelossa.

S Instruktioner till batteriboxen

Ta ut batterierna ur boxen om du inte skall använda den på länge, eller om batterierna är slut. Läckande vätska från gamla batterier skadar batteriboxen. Laddningsbara batterier kan användas. Ladda inte upp batterierna i batteriboxen.

P Instruções para utilização da Caixa de Pilhas

Retirar sempre as pilhas da caixa no caso de armazenagem prolongada ou se elas já estiverem gastas. O líquido vertido pelas pilhas gastas danificará a caixa de pilhas. Podem ser utilizadas pilhas recarregáveis. Não recarregue as pilhas na caixa.

H Utasítások az elemtartó használatához

Ha sokáig nem használod az elemeket vagy ha már lemerültek, vedd ki őket az elemtartóból. Az elhasznált elemekből kiáramló folyadék tönkretetheti az elemtartót. Feltölthető elemeket természetesen használhatsz, de élettartamuk rövidebb lehet. Soha ne töltsd fel az elemeket a elemtartóban.

GR Οδηγίες χρήσεως του κουτιού μπαταρίας

Όταν τις αποθηκεύετε για πολύ χρόνο ή όταν οι μπαταρίες έχουν χαλάσει, απομακρύντε τις πάντοτε από το κουτί μπαταρίας. Υγρό που στάζει από άδεις μπαταρίες θα χαλάσει το κουτί μπαταρίας. Επαναφορτιζόμενες μπαταρίες μπορούν να χρησιμοποιηθούν. Μην επαναφορτίζετε τις μπαταρίες μέσα στο κουτί.

TR Pili kutusu kullanma talimatı

Motolu uzun süre kullanmayacasanız pilleri kutuda bırakmayınız. Boşalan pilleri kutudan çıkarınız. Boşalan pillerin akması pil kutusuna zarar verebilir. Şarj edilebilen pilleri de kullanabilirsiniz, ancak bu durumda güç azalabilir. Pilleri kutunun içinde şarj etmeyiniz.

MAL Cara menggunakan kotak bateri

Jika tidak menggunakan motor atau bateri habis, keluarkan dari kotak. Kebocoran dari bateri yang habis akan merosakkan kotak. Bateri yang boleh dicas boleh digunakan tetapi kuasa tenaganya berkurangan. Jangan sekali-kali mencajkan bateri di dalam kotak.

日本語 電池ケース使用上のご注意

電池の寿命が切れた場合、または長期使用しない場合には、ケースから電池を抜いてください。切れた電池から液が漏れて、電池ケースを損傷することになります。充電式電池も使用できますが、パワーは弱くなる場合があります。なお、電池ケースの中で充電しないようご注意ください。

中文 電池盒使用說明

需要長期藏貯電池或者電池已經用盡的話，請把電池從電池盒內取出，從廢電池漏出來的液體會損壞電池盒。您可以使用充電式電池，但它們的電力比較弱。進行充電時，請勿把電池留在電池盒內。

عربي تعليمات استعمال صندوق البطارية

يجب دائماً مراعاة إزالة البطاريات من صندوق البطارية عند حفظها وعدم استعمالها لمدة طويلة أو عند انتهاء فعاليتها طاقتهما. كما وأنه يجب الأخذ في الإعتبار أن تسرب السائل من البطارية القديمة والتي إنتهت فعاليتها طاقتهما يؤدي إلى تلف صندوق البطارية. يمكن استعمال البطاريات التي يعاد شحنها، إلا أن ذلك قد يؤدي إلى تقليل وانخفاض الطاقة. يجب عدم إعادة شحن البطاريات في صندوق البطارية.

한국어 전전지 박스 사용법

전전지의 수명이 다한 경우나 장기간 사용하지 않을 때는 항상 전전지 박스로부터 전전지를 제거시켜 주십시오. 수명이 다한 전전지에서 액체가 나오면 전전지 박스를 상하게 합니다.

TH วิธีการใช้กล่องแบตเตอรี่

ควรออกแบตเตอรี่ออกจากกล่อง เมื่อไม่ได้ใช้งานเป็นระยะเวลานาน หรือเมื่อแบตเตอรี่หมดอายุ. น้ำยาที่รั่วออกจากแบตเตอรี่ที่หมดอายุแล้วจะทำให้กล่องแบตเตอรี่เสียหายได้. สามารถใช้แบตเตอรี่ประเภทชาร์จไฟได้ แต่กำลังไฟอาจลดลง. ห้ามชาร์จแบตเตอรี่ในกล่องใช้แบตเตอรี่.

